



/ HydroMet

User Manual

PreciBal

 **KISTERS**
Empowering decisions of tomorrow

Table of Contents

I	Disclaimer	4
II	Safety Instructions	5
Part I	Introduction	6
1.1	Measurements and Data Processing	6
1.2	Interfaces	6
1.3	Models and Catching Areas	7
1.4	Measurement of Precipitation Amount	7
1.5	Generating Pulses on the Contact Output	8
1.6	Measurement of Rain Intensity	8
1.7	Measurement of Bucket Content	8
1.8	Measurement of Temperature	8
Part II	Installation	10
2.1	General Requirement	11
2.2	Preparing the Precipitation Gauge for Mounting	11
2.3	Mounting the Precipitation Gauge on the Pedestal	11
2.4	Mounting the Precipitation Gauge on a Pole Using the Pole-Mounting Adapter	11
2.5	Finishing Installation	11
Part III	Configuration	13
3.1	Interfaces	13
3.2	External Connection	13
Part IV	Operation	14
4.1	Data Communication	14
4.1.1	SDI-12	16
4.1.2	RS-485	33
4.1.3	Table of Output Data	35
4.2	Diagnosis	37
4.2.1	SDI-12: Sensor Diagnosis	38
4.2.2	RS-485: Sensor Diagnosis	39
Part V	Maintenance	40
5.1	Emptying the Bucket	40
5.2	Visual Check	40
5.3	Cleaning	41
5.4	Heater Check	41
5.5	Adding Antifreeze	41
5.6	Checking Horizontal Position	41
5.7	Checking Accuracy of Measurement	41
Part VI	Repair	43

Part VII	Technical Data	44
Part VIII	Obligations of the Operator and Disposal	46
8.1	Obligations of the Operator	46
8.2	Dismantling / Disposal	46
Part IX	Appendices	48
9.1	HS PreciBal (RainBal) App	48
9.1.1	PreciBal/RainBal App Functionality in a Nutshell	48
9.1.2	Precibal/RainBal App – User Interface	48

I Disclaimer

The information provided in this manual was deemed accurate as of the publication date. However, updates to this information may have occurred.

This manual does not include all of the details of design, production, or variation of the equipment nor does it cover every possible situation which may arise during installation, operation or maintenance. KISTERS shall not be liable for any incidental, indirect, special or consequential damages whatsoever arising out of or related to this documentation and the information contained in it, even if KISTERS has been advised of the possibility of such damages.

Any errors found in any KISTERS product should be reported to KISTERS where every effort will be made to quickly resolve the problem.

Copyright Notice: No parts of this work may be reproduced in any form or by any means without the written permission of the publisher. KISTERS waives copyright for users to print out parts of the documentation in hard copy for their own use only.

Trademark Notice: KISTERS products and services referred to in this document are trademarks or registered trademarks of KISTERS. Other product names used may or may not be the trademarks of their respective owners.

© 2023 | KISTERS. Any rights not expressly granted herein are reserved.

This document is public.

II Safety Instructions

- Read the user manual including all operating instructions prior to installing, connecting and powering up the KISTERS PreciBal. The manual provides information on how to operate the product. The manual is intended to be used by qualified personnel, i.e. personnel that have been adequately trained, are sufficiently familiar with installation, mounting, wiring, powering up and operation of the product.
- Keep the user manual on hand for later reference!
- If you encounter problems understanding the information in the manual (or part thereof), please consult the manufacturer or its appointed reseller for further support.
- KISTERS PreciBal is intended to be used in hydrometeorological or environmental monitoring applications.
- Before starting to work, you have to check the functioning and integrity of the system.
 - Check for visible defects on the PreciBal, this may or may not include any or all of the following mounting facilities, connectors and connections, mechanical parts, internal or external communication devices, power supplies or power supply lines, etc.
 - If defects are found that jeopardize the operational safety, work must be stopped. This is true for defects found before starting to work as well as for defects found while working.
- Do not use the KISTERS PreciBal in areas where there is a danger of explosion.
- The present user manual specifies environmental/climatic operating conditions as well as mechanical and electrical conditions. Installation, wiring, powering up and operating the KISTERS PreciBal must strictly comply with these specifications.
- Perform maintenance only when tools or machinery are not in operation.
- If guards are removed to perform maintenance, replace them immediately after servicing.
- Never make any electrical or mechanical diagnostics, inspections or repairs under any circumstances. Return the product to the manufacturer's named repair centre. You can find information on how to return items for repair in the relevant section of the KISTERS website.



- Disposal instructions: After taking the KISTERS PreciBal out of service, it must be disposed of in compliance with local waste and environmental regulations. The KISTERS PreciBal is never to be disposed in household waste!



- Inputs and outputs of the device are protected against electric discharges and surges (so-called ESD). Do not touch any part of the electronic components! If you need to touch any part, please discharge yourself, i.e. by touching grounded metal parts.



- **WARNING:** A full bucket can be very heavy, it can weigh more than 25 kg! Be careful while emptying the bucket! Accidentally dropping the bucket on the load cell can damage the sensor.



- **RoHS Compliance Statement:** The instruments are in conformity with Directive 2015/863/EU on the restriction of the use of certain hazardous substances in electrical and electronic equipment.

1 Introduction

Thank you for choosing our product. We hope you will enjoy using the device.

KISTERS manufactures, sells, installs and operates quality instrumentation, data loggers and communication technology. Products are designed with passion for environmental monitoring and with a deep understanding of the quality, accuracy and robustness needed to fulfil the requirements of measurement practitioners in the field.

The present User Manual will help you understand, install and deploy the device. If, however, you feel that a particular information is missing, incomplete or confusing, please do not hesitate to contact us for further support!

The HS PreciBal is a precipitation gauge based on a weighing principle with totalisation method. The amount and the intensity of rainfall is determined by collecting liquid, mixed and solid precipitation in a bucket and by the continuous measuring of weight increments. Sophisticated algorithms are implemented to suppress impact of temperature fluctuations, vibrations caused by wind, or evaporation.

The heated version is equipped with a rim heater to prevent snow on the rim and to avoid snow capping and/or ice accretion inside the rim which could result in the decrease of catching area.

An antifreeze such as propylene glycol is used to decrease the freezing point when collecting solid precipitation. Propylene glycol is a water-based, non-toxic Polymer to be used in precipitation gauges based on totalisator weighing principle that are especially used for collecting mixed and solid precipitation. The collected solid precipitation will turn from solid into liquid by the decreased freezing point instead of using electrical energy as usually required for heated tipping bucket gauges.

The use of an antifreeze allows for lower power consumption in locations where there is no mains power, but which are powered by batteries or solar panels. This combination of antifreeze and heating is applicable, for example, at locations at higher altitudes with moderately humid ambient conditions. With this intelligent power supply to heat the rim at low power consumption, the formation of ice build-up and snow caps is prevented.

Note: It is not required to add synthetic oil on top of the pre-filled mix of antifreeze and water.

In general, the model PreciBal 314 with its wider orifice is ideal for high mountain application with or without utilizing the rim heater.

- [Measurements and Data Processing](#) 6
- [Interfaces](#) 6
- [Models and Catching Areas](#) 7
- [Measurement of Precipitation Amount](#) 7
- [Generating Pulses on the Contact Output](#) 8
- [Measurement of Rain Intensity](#) 8
- [Measurement of Bucket Content](#) 8
- [Measurement of Temperature](#) 8

1.1 Measurements and Data Processing

Principal measurements provided by HS PreciBal are:

- Amount of precipitation registered since previous reading
- Total amount of precipitation (since power-on)
- Amount of precipitation registered during current or previous precipitation
- Precipitation intensity
- Temperature (internal or ambient, depending on configuration)
- Weight of the bucket content
- Status values (e.g. heater on/off, 80% of bucket capacity reached)

The measurement of the precipitation amount is based on continuously measuring the weight of the bucket content. One **measurement cycle** takes **10 seconds**. At the end of each cycle all measured values are updated and prepared to be sent using a communication protocol. Any value can be read in any period greater or equal 10 seconds. Because of the algorithm implemented it can take up to 120 seconds to register complete amounts of precipitation fallen into the bucket, mainly depending on precipitation intensity and wind.

1.2 Interfaces

PreciBal is equipped with the SDI-12 version 1.4 serial interface, RS 485 and a contact voltage-free pulse output for emulation of a tipping-bucket rain gauge. RS-485 various protocols can be used, e.g. MODBUS RTU, MODBUS ASCII. For comfortable maintenance work the Bluetooth LE and USB-over-Bluetooth interface is available.

1.3 Models and Catching Areas

Two different models with 200 and 314 cm² orifice area with optional rim heater are available for specific regions with standard orifices standardized upon by the National weather services.

PreciBal 200 and PreciBal 200-RH: EU, LATAM, Canada, Africa, Russia-CIS

PreciBal 314 and PreciBal 314-RH: US, China, Asia-Pacific, Australia and New Zealand

Model	PreciBal 200	PreciBal 200-RH	PreciBal 314	PreciBal 314-RH
Orifice area [cm ²]	200	200	314	314
Diameter in mm/inch	160 / 6.4	160 / 6.4	200 / 7.9	200 / 7.9
Bucket capacity [l]	30	30	30	30
Approximate amount of precipitation for full bucket [mm]	1500	1500	1000	1000

1.4 Measurement of Precipitation Amount

Three principal amounts of precipitation are calculated (see figure [PR, PRTOT and PRLAST](#) ):

PR	<p>Amount of precipitation registered since previous reading.</p> <p>At power-up the value of PR is set to zero. At the end of each 10-second measurement cycle the precipitation amount registered during that cycle is added to the PR value. After reading by <i>aMI/aDO!</i> command pair the value of PR is set to zero.</p> <p>Note: The value is not set to zero if read by MODBUS protocol!</p>
PRTOT	<p>Total amount of precipitation.</p> <p>At power-up the value of PRTOT is set to zero. At the end of each 10-second measurement cycle the precipitation amount registered during that cycle is added to the PRTOT value. The value is never set to zero while the PreciBalRainBal is running continuously.</p>
PRLAST	<p>Amount of precipitation registered during current or previous precipitation.</p> <p>At power-up the value of PRLAST is set to zero. At the end of each 10-second measurement cycle the precipitation amount registered during that cycle is added to the PRLAST value. The value is set to zero if after a period of ten or more minutes with no precipitation it begins to rain (or snow). In other words: while it is raining the PRLAST is equal to the precipitation fallen from the beginning of current rain. After it has stopped raining the PRLAST remains unchanged thus it's equal to the precipitation fallen during previous rain. At the beginning of the next rain PRLAST is set to zero.</p>

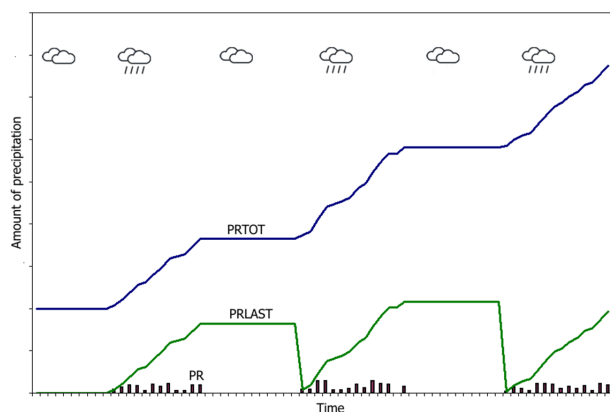

Figure 1 – PR, PRTOT and PRLAST

1.5 Generating Pulses on the Contact Output

At the end of each 10-second measurement cycle the PreciBal begins generating a series of pulses. The count of the pulses corresponds to the precipitation amount registered during that cycle and depends on the value of the **IMPRATIO** parameter (the amount of precipitation corresponding to one pulse). If there is not enough time to generate all pulses during one measurement cycle, the remaining pulses will be accumulated and sent during following cycles.

1.6 Measurement of Rain Intensity

A PreciBal rain gauge provides two rain intensity values: **RIINST** and **RI**. The value of **RIINST** represents an estimate of the instantaneous rain intensity calculated from the increase of the bucket content weight during one measurement cycle. The **RIINST** reacts quickly to the changes in real rain intensity. On the other hand the value of **RI** is the rain intensity calculated from one-minute data.

1.7 Measurement of Bucket Content

The value of **WAVG** represents a filtered weight of the bucket content including weight of the bucket itself.

1.8 Measurement of Temperature

In the standard version a PreciBal precipitation gauge, the electronic thermometer is placed inside the electronic unit housing. **T**, thus, represents the inside temperature. An external thermometer can be used instead of the internal one to measure the real ambient air temperature. The additional temperature values (**TAVG**, **TMIN**, **TMAX**) are one-minute values.

Heated version PreciBal 200-RH/314-RH

The heater is powered by a separate power supply and is switched on automatically if the temperature falls below a preset threshold. The heating supply voltage can range from 10 to 30 VDC. The heating power depends on the voltage, there is no power regulator.

The heated PreciBal model is equipped with an orifice rim heater to prevent snow and/or frost from accumulating on the rim. The heater is powered from a separate power supply and is switched on automatically if the temperature falls below a preset threshold. The heating supply voltage can range from 10 to 30 VDC. The heating power depends on the voltage, there is no power regulator.

Heating Mode 1

The heating can operate in one of four modes depending on the value of the **HEAT** parameter. Modes **0** (permanently off) and **1** (permanently on) are intended mainly for maintenance purposes, in modes **2** and **3** the heater is switched on or off automatically depending on the internal or ambient air temperature and the value of **THEAT** parameter.

Heating Mode 2

The heater is switched on if the temperature falls below the value of the **THEAT** parameter and switched off if the temperature rises above **THEAT** + 1°C. The factory preset value of **THEAT** is +4 °C.

Heating Mode 3

This mode can be used to save the heating energy. It is the same as mode 2 except that the heater is only switched on if precipitation is being detected. This allows the use of solar power packages and/or batteries during the winter period. In this case we do highly recommend to monitor and control the battery capacity by the connected data logger to measure battery voltage and current. In this case it is required that the logger is equipped with a relay to switch and connect the heater battery to the Heater terminals of the instrument.

Further support and consulting on request, depending on geographical location and altitude of the site.

2 Installation

See the separate PreciBal installation guide that is included in the scope of delivery and can be downloaded from the website.

Installation for Measuring Heights of 1.0 and 1.5 m

PreciBal can be mounted on a 2" threaded pole with ground plate corresponding to the HS TB series. In addition, a mechanical mount bracket HS 334 is required (3-point to inner threaded 2" pipe adapter).

See mounting Instructions: HS 334 Multi Adapter for PreciBal.

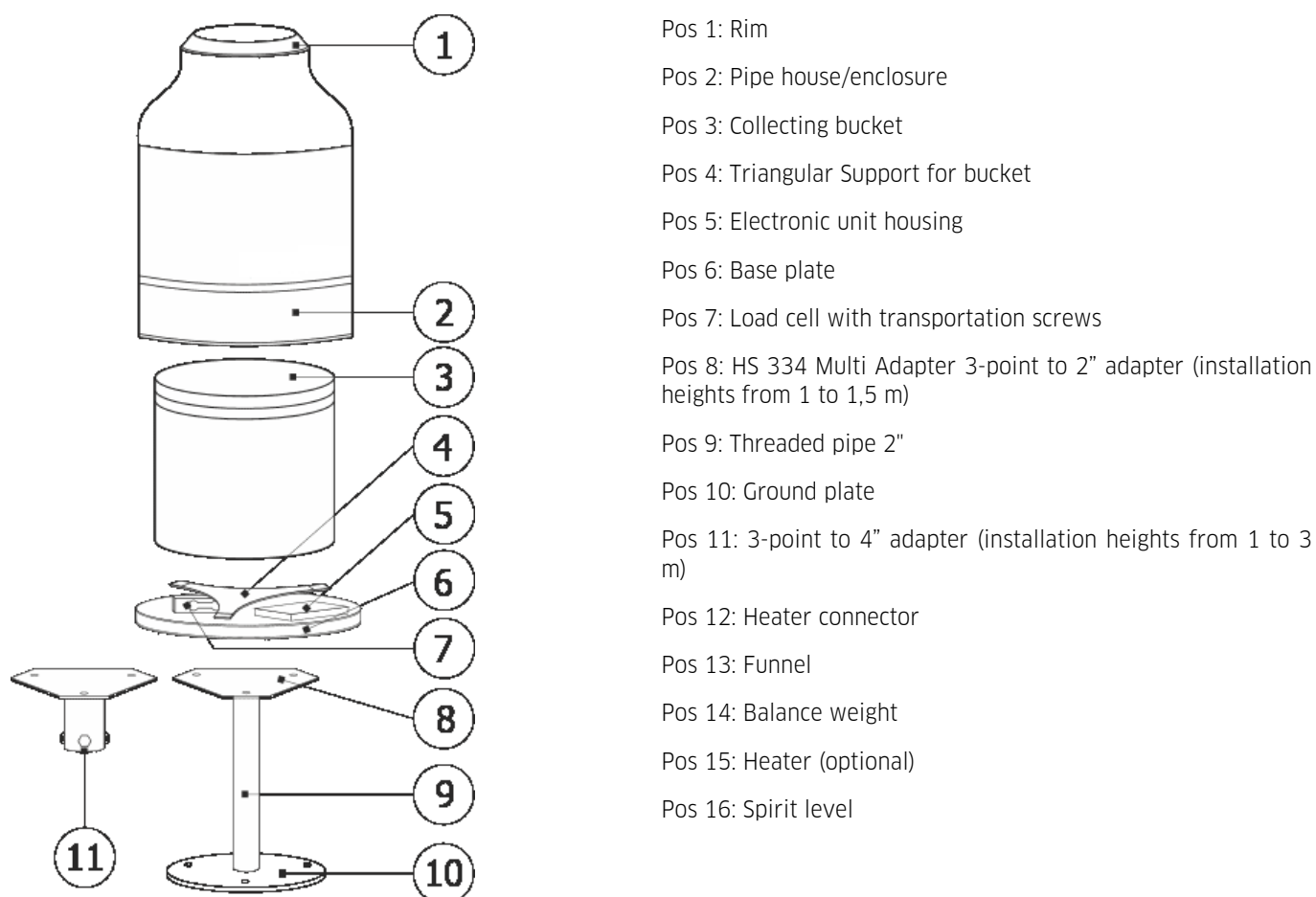

Top view of the measuring unit for PreciBal precipitation gauge:

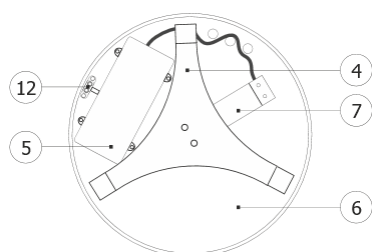

Figure 2 - Overview of sub-assemblies

Sub-assembly position 11: See Mounting instruction: 3-point to 4" pole adapter for PreciBal.





Measuring height PreciBal with HS 334X adapter	Pos 9: Length 2" threaded pipe
1.0 m	300 mm

Measuring height PreciBal with HS 334X adapter	Pos 9: Length 2" threaded pipe
1.5 m	800 mm

Installation for Measuring Heights of 1.0 and 3 m

PreciBal can be mounted on a 4" threaded pole with ground plate. In addition, a mechanical mount bracket HS 334X is required (3-point to inner threaded 4" pipe adapter).

Consult these chapters for installation instructions.

- [General Requirement](#) 
- [Preparing the Precipitation Gauge for Mounting](#) 
- [Mounting the Precipitation Gauge on the Pedestal](#) 
- [Mounting the Precipitation Gauge on a Pole Using the Pole-Mounting Adapter](#) 
- [Finishing Installation](#) 

2.1 General Requirement

The site for installing a precipitation gauge should be open but not too windy. The distance from the gauge to any surrounding object should be at least twice the height of the object above the gauge orifice. As for the height of the orifice please follow local regulations and/or requirements. The most commonly used height varies between 1.0 and 1.5 m above the surrounding terrain. In any case the orifice must be placed above the maximum expected depth of snow cover. Avoid installing the precipitation gauge on a slope or the roof of buildings.

Mounting the Pedestal

1. Prepare a concrete base and attach three M8 bolts to it (e.g. use wall plugs and hanger bolts).
2. Screw three M8 nuts onto the bolts and place the ground plate (10) of the threaded pipe (9) on them (see figure [Overview of sub-assemblies](#) ). **Note:** The ground plate is round but the HS 334 Multi-Adapter (8) is triangular.
3. Make the upper (instrument) flange (8) of the pedestal horizontal using a spirit level in two directions perpendicular to each other. Fix the pedestal using another three nuts and washers. Do not tighten the nuts yet.

2.2 Preparing the Precipitation Gauge for Mounting

Detach the enclosure (2) from the rain gauge base plate (6) loosening the screws at the bottom edge of the enclosure. Remove the bucket (3) from the base plate.

2.3 Mounting the Precipitation Gauge on the Pedestal

Attach the base plate (6) to the pedestal using three M8 screws. Place a spirit level on two ends of the support triangle (4) and adjust the level with the lower flange nuts if necessary. Place the spirit level on another two ends of the support triangle and repeat the procedure. Now tighten the nuts thoroughly.

2.4 Mounting the Precipitation Gauge on a Pole Using the Pole-Mounting Adapter

Set the mounting adapter (8 or 11) on the pole. Do not tighten the fixing screws yet. Attach the base plate (6) to the adapter using three M8 screws. Now level the base plate (6) using a spirit level and fixing screws of the adapter. Place the spirit level on two ends of the support triangle (4) or use the built-in spirit level (17) of the precipitation gauge. Finally tighten the fixing screws of the mounting adapter.

For more details, see the separate installation instructions on 3-point to 2"- and 3-point to 4" adapter with installation poles and ground plate for mounting onto concrete.

2.5 Finishing Installation

1. A classical precipitation gauge is fitted with two transport screws and a transport bracket to prevent damage of the load cell during transport (see figure [Transportation bracket](#) ). Loosen both screws so that there is a space of at least 1 millimetre between the tip of the screw and the body of the gauge (or the load cell, depending on PreciBal model). Remove the transport bracket.

- Put back the bucket (3) and the enclosure (2). Mind the right position of the enclosure: the male part of the heating connector has to be plugged into the female one located at the base plate of the rain gauge. Fix the enclosure tightening the screws around the lower edge.
- Use your finger to check if the rain gauge has been assembled correctly: the rim of the enclosure must not touch the bucket!

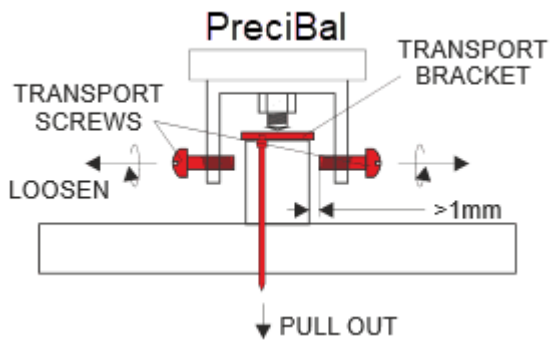

Figure 3 - Transportation bracket

3 Configuration

This chapter contains the following subsections:

- [Interfaces](#) ¹³¹
- [External Connection](#) ¹³¹

3.1 Interfaces

PreciBal is equipped with the SDI-12 version 1.4 serial interface, RS 485 and a contact voltage-free pulse output for emulation of a tipping-bucket rain gauge. RS-485 various protocols can be used, e.g. MODBUS RTU, MODBUS ASCII. For comfortable maintenance work the Bluetooth LE and USB-over-Bluetooth interface is available. The serial interfaces are both fully equipped and can be selected with the implemented protocols. Both interfaces cannot be operated simultaneously.

By default the interface is set to SDI-12 V1.4.

Possible interface settings						
Protocol	SDI-12		MODBUS		ASCII	
Interface	Settings	Address	Settings	Address	Settings	Address
SDI-12	1200,7,E,1	0	N/A	N/A	N/A	N/A
RS-485	9600,8,N,1	0	9600,8,E,1	48	9600,8,N,1	0

The pulse output is available in metric and imperial units with different pulse factors. Here the behaviour of a reed contact is simulated, which is usually integrated in tipping bucket rain gauges.

The pulse output is working simultaneously to any selected interface and protocol and can also be used as redundant output to be connected to a second device.

For changing the interface or other parameters, please [use the app](#) ⁴⁸¹ available for IOS and android smart phones.

More information see installation guide.

3.2 External Connection

See the separate PreciBal installation guide that is included in the scope of delivery and can be downloaded from the website.

On the bottom side of the base plate there are either M12-8pol or additionally M12-4pol (for the heated version) connectors with cap to utilize and connect the delivered cables. The bar ends or open wires have to be connected to the corresponding terminals of the data logger, AWS or SCADA system. A standard length of the cables is 10 meters but a cable of customs and site specific length can be ordered upon request.

The maximum length for the cables is 15 m for M12 SAC-4pol (heater cable) and 50 m for M12-8pol (instrument supply and interfaces).

Please use the APP to switch to RS 485 mode or other settings.

4 Operation

This chapter contains the following subsections:

- [Data Communication](#) ¹⁴
- [Diagnosis](#) ³⁷

4.1 Data Communication

Communication modes:

- Standard: SDI-12, Version 1.4, default address is '0'.
- Optional: RS-485: 9600bps, 8bit, no parity, 1 stop bit, default address is '0' - Modbus RTU and Modbus ASCII.

Protocols	PreciBal 200	PreciBal 314
SDI-12, Version 1.4	X	X
RS 485 Modbus	X	X

Table 1 - Protocols

The communication mode is preset to SDI-12.

Independent of the communication protocol in use, PreciBal stores all data in so-called “registers”. All measured and status values and parameters are stored in the registers. The table [Protocols](#) ¹⁴ describes the most important registers that you may need in order to work with the sensor.

Register acronym	Description
PR	Precipitation amount between two readings (SDI 12) M" command), after reading value is reset
PRTOT*	Precipitation amount from power ON, or reset up to 999.99mm
PRLAST*	Precipitation amount of present or last precipitation event, used for validation with weight or with water and for APP and SDI12.
WAVG*	Total weight of bucket
PRINST**	Instant precipitation between two readings with "M" command, delay is max. 10 sec.
RI**	Instant 10-sec rain intensity express in mm/h
PRcor	Corrected PR value
PRtot	Corrected PRTOT value
T	Temperature
TMIN	1-minute temperature minimum
TMAX	1-minute temperature maximum
TAVG	1-minute temperature average
U	Power supply
WS	Wind speed estimation used for corrected data
HEAT	Heating mode: 0 ~ heating OFF, 1 ~ heating ON, 2 ~ heating ON when temperature ('T') is below THEAT, 3 ~ heating ON when temperature ('T') is below THEAT and it rains
THEAT	Parameter: heating temperature threshold
IMRATIO	Parameter: precipitation that equals one pulse

Table 2 – Description of Registers

Note:

* For more information on how these values vary in time, refer to figure [PRTOT, PRLAST and WAVG - graphical view of variations in time](#)¹⁶¹.

** For more information on how these values vary in time, refer to figure [RI and 1-minute precipitation - graphical view of variations in time](#)¹⁶¹.

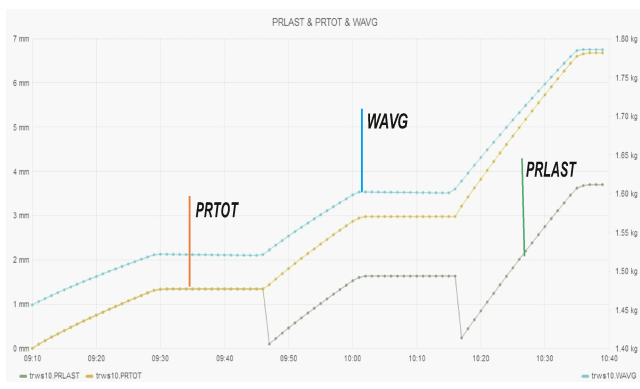

Figure 4 – PRTOT, PRLAST and WAVG – graphical view of variations in time

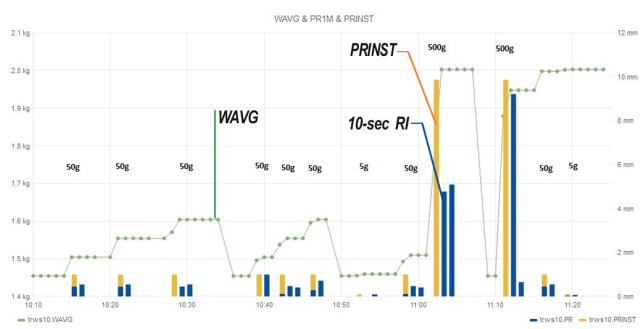

Figure 5 – RI and 1-minute precipitation – graphical view of variations in time

Follow the links for further information.

- [SDI-12](#) ¹⁶
- [RS-485](#) ³³
- [Table of Output Data](#) ³⁵

4.1.1 SDI-12

Only the most important commands are described here. For more information on SDI-12 protocol please visit www.sdi-12.org. In all examples in this section *a* represents a sensor address and *ccc* the 3 character CRC code, appended if data was requested with the *aMCI*, *aRCI* etc. command.

- [General SDI-12 Commands](#) ¹⁶
- [SDI-12 Measurement Commands \(Metric Units\)](#) ¹⁷
- [SDI-12 Measurement Commands \(Imperial Units\)](#) ²¹
- [SDI-12 Reading Status Commands](#) ²⁵
- [SDI-12 Verification](#) ²⁷
- [SDI-12 Settings](#) ²⁷
- [SDI-12 Sensor Maintenance \(Extended\) Commands](#) ³¹
- [SDI-12 Commands](#) ³²

4.1.1.1 General SDI-12 Commands

Address query	
Command:	? !
Response:	a<CR><LF>

Address query		
Explanation:	a	the sensor address
Example:	?!0<CR><LF>	

Change address		
Command:	aAb!	
Response:	b<CR><LF>	
Explanation:	a	the original address
	b	the new address
Example:	0A3!3<CR><LF>	

Send identification		
Command:	aI!	
Response:	a14HYQUESTPRECIB1011400,SN=2595<CR><LF>	
Explanation:	HYQUEST	company name
	PRECIB10	sensor model
	11400	sensor version (1.14.00)
	SN=2595	serial number

4.1.1.2 SDI-12 Measurement Commands (Metric Units)

Basic data (amount of precipitation and weight)

Basic data (amount of precipitation and weight)

Start measurement

Command:	aM! aMC!
----------	-------------

Response:	a0003<CR><LF>
-----------	---------------

Send data

Command:	aD0!
----------	------

Response:	a+PR±WAVG+PRTOT<CR><LF> a+PR±WAVG+PRTOTccc<CR><LF>
-----------	---

Explanation:	PR	amount of precipitation registered since previous reading [mm]
	WAVG	weight of the bucket content [g]
	PRTOT	total amount of precipitation [mm]

Example

```
0M!00003<CR><LF>
0D0!0+0.130+2893.481+116.443<CR><LF>
0MC!00003<CR><LF>
0D0!0+2.5+49.074+2.5Dsk<CR><LF>
```

Precipitation intensity and last or current rain precipitation amount

Start measurement

Command:	aM1! aMC1!
----------	---------------

Response:	a0003<CR><LF>
-----------	---------------

Send data

Precipitation intensity and last or current rain precipitation amount

Command:	aD0!	
Response:	a+PRLAST+RIINST+RI<CR><LF> a+PRLAST+RIINST+RIccc<CR><LF>	
Explanation:	PRLAST	amount of precipitation registered during current or previous precipitation [mm]
	RIINST	instantaneous precipitation intensity [mm/h]
	RI	one-minute precipitation intensity [mm/h]
Example		
	<pre> OM1!00003<CR><LF> OD0!0+3.794+2.5+1.3<CR><LF> OMC1!00003<CR><LF> OD0!0+2.5+0+0BrY<CR><LF> </pre>	

Temperature and service data

Start measurement		
Command:	aM2! aMC2!	
Response:	a0006<CR><LF>	
Send data		
Command:	aD0!	
Response:	a±T±TMIN±TAVG±TMAX+U+STATUS<CR><LF> a±T±TMIN±TAVG±TMAX+U+STATUSccc<CR><LF>	
Explanation:	T	temperature [°C]
	TMIN	one-minute temperature minimum value [°C]

Temperature and service data

	TAVG	one-minute temperature average value [°C]
	TMAX	one-minute temperature maximum value [°C]
	U	internal power supply voltage [V]
	STATUS	various status data [-]

Example

```

0M2!00006<CR><LF>
0D0!0+10.80+10.80+10.80+10.81+3.327+1<CR><LF>
0MC2!00006<CR><LF>
0D0!0+21.85+21.84+21.85+21.85+3.306+1DmY<CR><LF>

```

Corrected precipitation amount data

Start measurement

Command:	aM3! aMC3!
Response:	a0003<CR><LF>

Send data

Command:	aD0!
Response:	a+PRcor+PRTOTcor+WS<CR><LF> a+PRcor+PRTOTcor+WSccc<CR><LF>

Explanation:	PRcor	corrected amount of precipitation [mm]
	PRTOTcor	corrected total amount of precipitation [mm]
	WS	estimate of wind speed [dimensionless quantity]

Example

Corrected precipitation amount data

```

0M3!00003<CR><LF>
0D0!0+0.150+121.511+2.3<CR><LF>
0MC3!00003<CR><LF>
0D0!0+2.677+2.677+0.9KDC<CR><LF>

```

Instantaneous precipitation amount

Start measurement

Command:	aM4! aMC4!
----------	---------------

Response:	a0001<CR><LF>
-----------	---------------

Send data

Command:	aD0!
----------	------

Response:	a+PRINST<CR><LF> a+PRINSTccc<CR><LF>
-----------	---

Explanation:	PRINST	instantaneous precipitation [mm]
--------------	--------	----------------------------------

Example

```

0M4!00001<CR><LF>
0D0!0+0.251<CR><LF>
0MC4!00001<CR><LF>
0D0!0+2.5I`u<CR><LF>

```

4.1.1.3 SDI-12 Measurement Commands (Imperial Units)**Basic data (amount of precipitation and weight), imperial units**

Start measurement

Basic data (amount of precipitation and weight), imperial units

Command:	aM5! aMC5!	
Response:	a0003<CR><LF>	
Send data		
Command:	aD0!	
Response:	a+I_R±I_WAVG+I_PRTOT<CR><LF> a+I_R±I_WAVG+I_PRTOTccc<CR><LF>	
Explanation:	I_PR	amount of precipitation registered since previous reading [in]
	I_WAVG	weight of the bucket content [oz]
	I_PRTOT	total amount of precipitation [in]
Example		
	<pre> 0M5!00003<CR><LF> 0D0!0+0.00512+102.06454+4.58437<CR><LF> 0MC5!00003<CR><LF> 0D0!0+0.09839+1.73082+0.19681AcI<CR><LF> </pre>	

Precipitation intensity and last or current rain precipitation amount, imperial units

Start measurement		
Command:	aM6! aMC6!	
Response:	a0003<CR><LF>	
Send data		
Command:	aD0!	

Precipitation intensity and last or current rain precipitation amount, imperial units

Response: a+I_PRLAST+I_RIINST+I_RI<CR><LF>
a+I_PRLAST+I_RIINST+I_RIccc<CR><LF>

Explanation:	I_PRLAST	amount of precipitation registered during current or previous precipitation [in]
	I_RIINST	instantaneous precipitation intensity [in/h]
	I_RI	one-minute precipitation intensity [in/h]

Example

```
0M6!00003<CR><LF>
0D0!0+0.14937+0.09843+0.05118<CR><LF>
0MC6!00003<CR><LF>
0D0!0+0.09839+0.000+0.000E}g<CR><LF>
```

Temperature and service data, imperial units

Start measurement

Command: aM7!
aMC7!

Response: a0006<CR><LF>

Send data

Command: aD0!

Response: a±I_T±I_TMIN±I_TAVG±I_TMAX+U+STATUS<CR><LF>
a±I_T±I_TMIN±I_TAVG±I_TMAX+U+STATUSccc<CR><LF>

Explanation:	I_T	temperature [°F]
	I_TMIN	one-minute temperature minimum value [°F]
	I_TAVG	one-minute temperature average value [°F]

Temperature and service data, imperial units

	I_TMAX	one-minute temperature maximum value [°F]
	U	internal power supply voltage [V]
	STATUS	various status data [-]

Example

```
0M7!00006<CR><LF>
0D0!0+51.44+51.44+51.44+51.46+3.327+1<CR><LF>
0MC7!00006<CR><LF>
0D0!0+71.31+71.29+71.31+71.31+3.306+1BRQ<CR><LF>
```

Corrected precipitation amount data, imperial units

Start measurement

Command:	aM8! aMC8!
Response:	a0003<CR><LF>

Send data

Command:	aD0!
Response:	a+I_PRCor+I_PRTOTcor+WS<CR><LF> a+I_PRCor+I_PRTOTcor+WSccc<CR><LF>

Explanation:	I_PRCor	corrected amount of precipitation [in]
	I_PRTOTcor	corrected total amount of precipitation [in]
	WS	estimate of wind speed [dimensionless quantity]

Example

```
0M8!00003<CR><LF>
```

Corrected precipitation amount data, imperial units

```

0D0!0+0.00591+4.78390+2.3<CR><LF>
0MC8!00003<CR><LF>
0D0!0+0.09839+0.20378+0FY<CR><LF>

```

Instantaneous precipitation amount, imperial units

Start measurement

Command: aM9!
aMC9!

Response: B0001<CR><LF>

Send data

Command: aD0!

Response: a+I_PRINST<CR><LF>
a+I_PRINSTccc<CR><LF>

Explanation: I_PRINST instantaneous precipitation amount [in]

Example

```

0M9!00001<CR><LF>
0D0!0+0.00988<CR><LF>
0MC9!00001<CR><LF>
0D0!0+0.09843F^z<CR><LF>

```

4.1.1.4 SDI-12 Reading Status Commands**Reading status byte (mapped per bit)**

Command: aR0!
aRC0!

Response: a+STATUS<CR><LF>

Reading status byte (mapped per bit)

	a+STATUSccc<CR><LF>	
Explanation:	STATUS	status register, mapped per bit
Example:	0R0!0+1<CR><LF> 0RC0!0+1Bo_<CR><LF>	

Reading status bits

Command:	aR1! aRC1!	
Response:	a+STATUS0+STATUS1+STATUS2+STATUS3+STATUS4+STATUS5+STATUS6 +STATUS7<CR><LF> a+STATUS0+STATUS1+STATUS2+STATUS3+STATUS4+STATUS5+STATUS6 +STATUS7ccc<CR><LF>	
Explanation:	STATUS0	1: activated
	STATUS1	1: 80% of bucket capacity reached
	STATUS2	1: unexpected restart detected
	STATUS3	(reserved)
	STATUS4	1: heater is on
	STATUS5	(reserved)
	STATUS6	(reserved)
	STATUS7	(reserved)
Example:	0R1!0+1+0+0+0+0+0+0+0<CR><LF> 0RC1!0+1+0+0+0+0+0+0+0GuL<CR><LF>	

4.1.1.5 SDI-12 Verification

Verification		
Start verification		
Command:	aV!	
Response:	a0001<CR><LF>	
Send verification data		
Command:	aD0!	
Response:	a+PRLAST<CR><LF>	
Explanation:	PRLAST	amount of precipitation registered during verification (mm or in, depending on UNITS set)
Example		
	<pre>0V!00001<CR><LF> 0D0!0+2.508<CR><LF></pre>	

For more information on the sensor verification procedure consult ch. [Maintenance](#) ⁴⁰.

4.1.1.6 SDI-12 Settings

Setting measurement units		
Command:	aXset 190 B!	
Response:	aOK<CR><LF>	
Explanation:	UNITS	measurement units: 0: metric 1: imperial

Setting measurement units

Example: 0Xset | 190 | 1 ! 00K <CR> <LF>

Setting the amount of precipitation corresponding to one pulse on contact output

Command: aXset | 176 | IMPRATIO!

Response: aOK <CR> <LF>

Explanation: IMPRATIO amount of precipitation corresponding to one pulse on contact output
(0.01 ... 1 mm)

Example: 0Xset | 176 | 0 . 1 ! 00K <CR> <LF>

Setting the temperature threshold for heating

Command: aXset | 5 | THEAT!

Response: aOK <CR> <LF>

Explanation: THEAT the temperature below which the heater is switched on [°C]

Example: 0Xset | 5 | 2 . 5 ! 00K <CR> <LF>

Setting the heating mode

Command: aXset | 4 | HEAT!

Response: aOK <CR> <LF>

Explanation: HEAT heating mode:
0: permanently off
1: permanently on
2: on if temperature is below threshold
3: on if temperature is below threshold and if it is raining or snowing

Setting the heating mode

Example:	0Xset 4 3 ! 00K<CR><LF>
----------	-----------------------------

Setting the communication protocol on RS-485 interface

Command:	aXset 3 RS485 !
----------	---------------------

Response:	aOK<CR><LF>
-----------	-------------

Explanation:	RS485	<p>communication protocol on RS-485:</p> <p>0: no RS-485 interface</p> <p>1: MODBUS RTU</p> <p>2: MODBUS ASCII</p> <p>3: HyQuest protocol</p> <p>4: SDI-12</p> <p>5: User 1</p> <p>6: VAISALA VRG</p>
--------------	-------	---

Example:	0Xset 3 1 ! 00K<CR><LF>
----------	-----------------------------

Setting the serial communication parameters

Setting the Baud rate

Command:	aXset 48 BAUD !
----------	---------------------

Response:	aOK<CR><LF>
-----------	-------------

Explanation:	BAUD	Baud rate (300, 600, 1200, 2400, 4800, 9600, 19200, 38400, 57600, 115200)
--------------	------	---

Example:	0Xset 48 1200 ! 00K<CR><LF>
----------	---------------------------------

Setting number of data bits

Setting the serial communication parameters

Command: aXset | 49 | DATA!

Response: aOK<CR><LF>

Explanation: DATA number of data bits (5, 6, 7, 8, 9)

Example: 0Xset | 49 | 7!0OK<CR><LF>

Setting parity

Command: aXset | 50 | PARITY!

Response: aOK<CR><LF>

Explanation: PARITY parity (n, e, o)

Example: 0Xset | 50 | e!0OK<CR><LF>

Setting number of stop bits

Command: aXset | 51 | STOP!

Response: aOK<CR><LF>

Explanation: STOP number of stop bits (1, 2)

Example: 0Xset | 51 | 1!0OK<CR><LF>

Getting and setting measurement parameters

Getting measurement parameters

Getting and setting measurement parameters		
Command:	aXmsg M! aXmsg Mi!	
Response:	aLIST<CR><LF>	
Explanation:	i	the number of an additional measurement (1...9)
	LIST	a semicolon-separated list of internal register numbers
Example:	0Xmsg M!0145;146;157<CR><LF> 0Xmsg M5!0241;252;243<CR><LF>	
Setting measurement parameters		
Command:	aXmsg M LIST! aXmsg Mi LIST!	
Response:	aOK<CR><LF>	
Explanation:	i	the number of an additional measurement (1...9)
	LIST	a semicolon-separated list of internal register numbers
Example:	0Xmsg M5 241;252;243!00K<CR><LF>	

4.1.1.7 SDI-12 Sensor Maintenance (Extended) Commands

Resetting PRTOT and PRLAST values	
Command:	aXclear!
Response:	aOK<CR><LF>
Explanation:	Both PRTOT and PRLAST values (total precipitation amount and current/previous precipitation amount) are set to zero. The aXclear! command performs the same action as Data reset in the KISTERS PreciBal (RainBal) App ⁴⁸ .

Resetting PRTOT and PRLAST values

Example: 0Xclear!00K<CR><LF>

4.1.1.8 SDI-12 Commands

Identify measurement commands

Command:
aIM!
aIMi!
aIV!
etc.

Response: a000n<CR><LF>

Explanation: i the number of an additional measurement (1...9)

n the number of measurement values the sensor will take and return

Examples:
0IM!00003<CR><LF>
0IM2!00006<CR><LF>
0IV!00001<CR><LF>
etc.

Identify measurement parameter commands

Command:
aIM_ppp!
aIMi_ppp!
aIV_ppp!
etc.

Response: a, ID, UNIT, REGNO, TYPE, ATTR, DECIMAL, MIN, MAX; <CR><LF>

Explanation: i the number of an additional measurement (1...9)

ppp the order number of a measured parameter

ID concise identification of the parameter

Identify measurement parameter commands		
	UNIT	unit of measurement
	REGNO	internal register number
	TYPE	internal data type (e.g. FLOAT, UINT8, UINT32, CHAR, BOOL etc.)
	ATTR	attribute (RO: read only, RW: read/write)
	DECIMAL	decimal places
	MIN	minimum possible value
	MAX	maximum possible value
Examples:		
	0IM_001!0, PR, mm, 145, FLOAT, RO, 3, 0, 9999, ; <CR><LF>	
	0IM_002!0, WAVG, g, 146, FLOAT, RO, 3, -60000, 60000, ; <CR><LF>	
	0IV_001!0, PRLAST, mm, 156, FLOAT, RO, 3, 0, 9999, ; <CR><LF>	
	etc.	

4.1.2 RS-485

Over RS-485 three main protocols are available: MODBUS (RTU, ASCII), SDI-12. You can select the protocol by setting the **RS485** parameter to the desired value.

- [SDI-12 Protocol over RS-485](#) ³³
- [ASCII Protocol](#) ³³
- [MODBUS Protocol](#) ³⁴

4.1.2.1 SDI-12 Protocol over RS-485

Commands and responses are the same as those on the [SDI-12](#) ¹⁶ interface. Initial BREAK is not required.

4.1.2.2 ASCII Protocol

Only the request of a basic set of data commands is implemented. **Note**, that unlike SDI-12 and MODBUS, the ASCII protocol provides integer values only; that is why precipitation amounts are in micrometres and the weight is in milligrams. The ASCII protocol shares its address with the SDI-12 protocol.

Requesting basic data (amount of precipitation and weight)		
Command:	<ENQ>a<CR>	
Response:	<SOH>a<STX>PR<TAB>WAVG<TAB>PRTOT<ETX><CR><LF>	
Explanation:	PR	amount of precipitation registered since previous reading [μ m]
	WAVG	weight of the bucket content [mg]

Requesting basic data (amount of precipitation and weight)

	PRTOT	total amount of precipitation [µm]
--	-------	------------------------------------

4.1.2.3 MODBUS Protocol

The default (factory preset) device address is **48**. Use function code **04** (read input registers) to read data from the sensor. For list of registers see the table below. Since all measurements are of type float, read two consecutive registers to get a value. For more information on MODBUS protocol, please visit www.modbus.org.

Note:

- To change the address use the corresponding SDI-12 command (ch. [Reset/Clear Cumulative Precipitation Counters](#)^[38]) or the [KISTERS PreciBal \(RainBal\) App](#)^[48].
- The MODBUS protocol shares the address with the SDI-12 protocol but its interpretation is different: While the SDI-12 address is a **character**, the MODBUS address represents the **ASCII code** of the SDI-12 address (e.g. SDI-12 address **0** = MODBUS address **48**).

MODBUS input registers (function code 04)

Measurement name	Explanation	Register address	Register count	Data type
PR	amount of precipitation registered since recent power-on or software restart of the instrument [mm]	290	2	float
WAVG	weight of the bucket content [g]	292	2	float
TAVG	one-minute temperature average value [°C]	294	2	float
PRLAST	amount of precipitation registered during current or previous precipitation [mm]	312	2	float
PRTOT	total amount of precipitation [mm]	314	2	float
I_PR	amount of precipitation registered since recent power-on or software restart of the instrument [in]	482	2	float
I_PRLAST	amount of precipitation registered during current or previous precipitation [in]	484	2	float
I_PRTOT	total amount of precipitation [in]	486	2	float
I_TAVG	one-minute temperature average value [°F]	490	2	float
I_WAVG	weight of the bucket content [oz]	504	2	float

4.1.3 Table of Output Data

(Configuration parameters are highlighted.)

Internal register number	Register name	Description	Unit	Range	Resolution	Type
3	RS485	Communication protocol on RS-485 interface	-	0: no RS-485 intfc. 1: MODBUS RTU 2: MODBUS ASCII 3: HyQuest protocol 4: SDI-12 5: User 1 6: VAISALA VRG	1	uint8
4	HEAT	Heating mode	-	0: permanently off 1: permanently on 2: on if Ta<THEAT 3: on if Ta<THEAT and is raining or snowing	1	uint8
5	THEAT	Temperature threshold for heating	°C	-70 ... 125	0.1	float
48	BAUD	Baud rate (RS-485)	baud	300 ... 115200	N/A	uint32
49	DATABIT	Number of data bits (RS-485)	-	5 ... 9	1	uint8
50	PARITY	Parity (RS-485)	-	n,e,o	N/A	char
51	STOPBIT	Number of stop bits	-	1 ... 2	1	uint8
64	U	Internal power supply voltage	V	0 ... 5	0.001	float
65	T	Temperature	°C	-50 ... 70	0.01	float
66	STATUS	Status data (values of registers STATUS0..STATUS7)	-	0 ... 255	1	uint8
80	STATUS0	1: Sensor activated	-	0 ... 1	1	bool
81	STATUS1	1: 80% of bucket capacity reached	-	0 ... 1	1	bool
82	STATUS2	1: Unexpected restart detected	-	0 ... 1	1	bool
83	STATUS3	reserved	-	0 ... 1	1	bool
84	STATUS4	1: heater is on	-	0 ... 1	1	bool

Internal register number	Register name	Description	Unit	Range	Resolution	Type
85	STATUS5	reserved	-	0 ... 1	1	bool
86	STATUS6	reserved	-	0 ... 1	1	bool
87	STATUS7	reserved	-	0 ... 1	1	bool
145	PR	Amount of precipitation	mm	0 ... 9999	0.001	float
146	WAVG	Weight of the bucket content	g	-3000 ... 33000	0.001	float
147	TAVG	One-minute temperature average	°C	-50 ... 70	0.01	float
156	PRLAST	Amount of precipitation registered during current or previous precipitation	mm	0 ... 9999	0.001	float
157	PRTOT	Total amount of precipitation	mm	0 ... 9999	0.001	float
160	RI	One-minute precipitation intensity	mm/h	0 ... 3600	0.1	float
162	PRcor	Corrected amount of precipitation	mm	0 ... 9999	0.001	float
165	PRTOTcor	Corrected total amount of precipitation	mm	0 ... 9999	0.001	float
167	RIINST	Instantaneous precipitation intensity	mm/h	0 ... 3600	0.1	float
169	TMIN	One-minute temperature minimum value	°C	-50 ... 70	0.01	float
170	TMAX	One-minute temperature maximum value	°C	-50 ... 70	0.01	float
171	PRINST	Instantaneous precipitation amount	mm	0 ... 9999	0.001	float
174	WS	Estimate of wind speed	-	0 ... 999	0.1	float
176	IMPRATIO	Amount of precipitation corresponding to one pulse on contact output	mm	0.01 ... 1	0.01	float
190	UNITS	Measurement units	-	0: metric 1: imperial	1	uint8
240	I_T	Temperature	°F	-58 ... 158	0.01	float
241	I_PR	Amount of precipitation	in	0 ... 393.662	0.00001	float
242	I_PRLAST	Amount of precipitation registered during current or previous	in	0 ... 39.331	0.00001	float

Internal register number	Register name	Description	Unit	Range	Resolution	Type
		precipitation				
243	I_PRTOT	Total amount if precipitation	in	0 ... 393.662	0.00001	float
244	I_RIINST	Instantaneous precipitation intensity	in/h	0 ... 142	0.001	float
245	I_TAVG	One-minute temperature average	°F	-58 ... 158	0.01	float
246	I_TMIN	One-minute temperature minimum value	°F	-58 ... 158	0.01	float
247	I_TMAX	One-minute temperature maximum value	°F	-58 ... 158	0.01	float
248	I_PRINST	Instantaneous precipitation amount	in	0 ... 393.662	0.00001	float
249	I_PRCor	Corrected amount of precipitation	in	0 ... 393.662	0.00001	float
250	I_PRTOTcor	Corrected total amount if precipitation	in	0 ... 393.662	0.00001	float
252	I_WAVG	Weight of the bucket content	oz	-106 ... 1165	0.00001	float
253	I_RI	One-minute precipitation intensity	in/h	0 ... 142	0.001	float

4.2 Diagnosis

Practice of diagnosis (mechanical items – see figure [Overview of sub-assemblies](#) 

1. Turn the PreciBal on and let it stabilise for about three minutes.
2. Put a weight or pour a known amount of water into the bucket. **Note:** Weights must be placed in the center of the bucket. The enclosure must be in place.
3. Check the output from the PreciBal impulse output and/or serial output (SDI-12 or RS-485). Follow the instructions in the following chapters for serial SDI-12 and serial RS-485 communication. Reference values for representative weights and areas can be found in the [Verification Procedure Reference Table](#) .

Weight [g]	PreciBal 200: Pr [mm]			PreciBal 314: Pr [mm]		
	min.	nom.	max.	min.	nom.	max.
20	0,990	1,000	1,010	0,666	0,673	0,680
25	1,238	1,250	1,263	0,690	0,696	0,703
50	2,475	2,500	2,525	1,577	1,592	1,608
100	4,950	5,000	5,050	3,155	3,185	3,215
200	9,900	10,000	10,10	6,310	6,370	6,430

Table 3 - Verification Procedure Reference Table, Relative Accuracy 1%

Follow the links for further information.

- [SDI-12: Sensor Diagnosis](#)
- [RS-485: Sensor Diagnosis](#)

4.2.1 SDI-12: Sensor Diagnosis

This chapter contains the following subsections:

- [Step 1: Reset/Clear Cumulative Precipitation Counters](#)
- [Step 2: Put Known Weight and Wait](#)
- [Step 3: Read Data & Check Precipitation Value](#)

4.2.1.1 Step 1: Reset/Clear Cumulative Precipitation Counters

- Command: `aXreset!`
- Response: `aOK<CR><LF>`
 - resets the statistic calculation module,
 - rainfall counter {PRTOT} set to zero
- Example:
 - Command: `1Xreset!`
 - Response: `1OK<CR><LF>`

4.2.1.2 Step 2: Put Known Weight and Wait

- (A) Carefully deposit a known precision weight in the centre of the PreciBal bucket; reference weights are illustrated in the [Verification Procedure Reference Table](#)
- (B) Wait for at least three minutes for the accumulated precipitation calculation to complete.

4.2.1.3 Step 3: Read Data & Check Precipitation Value

- To start the diagnosis/verification process, send the following command:
 - Command: `aV!`
 - Response: `atttn<CR><LF>`
- To read data from the PreciBal, send the following command:
 - Command: `aD0!`
 - Response: `a<Reg.Val.156><CR><LF>`
Here `<Reg.Val.156>` corresponds to **PRLAST** and contains the precipitation equivalent in mm corresponding to the inserted weight.
- Compare measured value with the reference value and evaluate according to the validity range in the [Verification Procedure Reference Table](#)
- Example:
 - Command: `1V!<CR>`
 - Response: `10001<CR><LF>`

- Command: 1D0!<CR>
- Response: 1+1.247<CR><LF>
Here <Reg.Val.156> corresponds to **PRLAST** and 1.247 mm is the precipitation equivalent in mm for a PreciBal with an orifice $\varnothing = 200 \text{ cm}^2$ and an inserted precision weight of 25 g.
- Test successfully passed because $1.238 \text{ mm} \leq 1.247 \text{ mm} \leq 1.263 \text{ mm}$.

4.2.2 RS-485: Sensor Diagnosis

For the sensor diagnosis the SDI-12 protocol is used on the RS-485 port. Subsequently, the entire diagnosis follows the same steps and uses the same commands as described in ch. [SDI-12: Sensor Diagnosis](#) ³⁸.

5 Maintenance



WARNING

A full bucket can be very heavy, it can weigh more than 25 kg! Be careful while emptying the bucket. Accidentally dropping the bucket on the load cell can damage the sensor.

- Generally, thanks to its design and measurement principle, the PreciBal precipitation gauge requires very low maintenance. However, to guarantee a long-term and a trouble-free operation it is recommended to perform some simple maintenance tasks on a regular basis (see the table below).
- The periodical maintenance should be preferably performed at the beginning and at the end of the winter season and during a dry period to prevent loss in precipitation while maintenance work is performed.
- At the beginning of any maintenance work switch the sensor to the maintenance mode in order to prevent it from registering fake precipitation during the work. If you forget to switch the maintenance mode off when finished, the maintenance mode will be switched off after 30 minutes automatically.

Summary of recommended maintenance tasks	
Task	Period
Emptying the bucket* 40	if filled to more than 80 % of full capacity
Visual check 40	twice a year
Cleaning 41	twice a year or as necessary
Checking heater 41	once a year, at the beginning of winter season
Adding antifreeze* 41	at the beginning of winter season or as necessary
Checking horizontal position 41	once a year, at the end of winter season
Checking accuracy of measurement 41	once a year, at the end of winter season

5.1 Emptying the Bucket

Empty the bucket if it is filled to more than 80% of its full capacity or if you perform a regular maintenance. Check the status register to determine if the bucket needs to be emptied. Use the R0 or R1 commands (SDI-12) or the [KISTERS PreciBal \(RainBal\) App](#) [48](#) to do this.

Procedure:

1. Loosen the three screws fixing the enclosure and detach it from the base plate by lifting it up.
2. Carefully lift the bucket up and drain it. As a full bucket can be very heavy, better use a small bucket or a mug to drain some water before lifting it up. If there is an antifreezing agent inside, do not dispose the content into the environment. Follow your local environmental regulations.
3. Clean the inside of the bucket and put it back to its place. Put back the enclosure and tighten the three screws on its lower edge.
4. Use your finger to check if everything has been assembled correctly: the bucket must not touch the enclosure!

5.2 Visual Check

Check if there is any visible damage, if the rain gauge is correctly assembled and if all screws are tightened. Always check if there is no contact between the bucket and the enclosure. Check if the bucket of an E-series precipitation gauge can be tipped freely.

5.3 Cleaning

Remove any dirt (dust, leaves, insects, insect nests, spider's webs etc.) from both inside and outside parts of the precipitation gauge. Use a brush and/or a soft cloth and clean water or mild detergent.

5.4 Heater Check

Run the [HS APP application](#) ⁴⁶⁾, connect to the PreciBal and on the `Settings` screen change the heating mode to 1 (permanently on). Wait for about five minutes and check with your hand if the rim (or internal heater) has become warm. Don't forget to switch the heating mode back to automatic (2 or 3).

5.5 Adding Antifreeze

If negative temperatures are expected it is recommended to add some antifreeze into the bucket to melt the solid precipitation and to prevent the content of the bucket from freezing completely. Empty the bucket before adding the antifreeze. Prefer some non corrosive and environmentally friendly antifreeze like propylene glycol. As for the amount it depends on the lowest temperature awaited. Please consult the technical specification of the antifreeze.

An antifreeze such as propylene glycol is utilised to decrease the freezing point of collecting solid precipitation. Propylene glycol is water-based, non-toxic and non-hygroscopic Polymer to be utilised in totalisator weighing precipitation gauges especially for collecting mixed and solid precipitation.

In general, it is not required to add synthetic oil on top of the pre-filled mix of antifreeze with water.

Please fill the antifreeze solution in the following mixing ratio into the bucket of the PreciBal:

Antifreeze	water	Antifreeze protection for filling level 50%	Antifreeze protection for filling level 80%
5.0 l	2.0 l	-15 °C	- 8 °C
7.5 l	3.0 l	-34 °C	- 4 °C

Attention: Never use the anti-freeze undiluted when you do not add oil on top of the surface! Always add 40 volume per cent water. The pure anti-freeze is hygroscopic and may adhere humid air onto the water surface.

Anti-freeze protection is ensured already when mixture of propylene glycol/water and precipitation is not completely frozen but started to thaw. The content of the container does not need to be completely unfrozen. The bucket will not be damaged even when deep frozen.

5.6 Checking Horizontal Position

For quick check of horizontal position just place a spirit level in two directions perpendicular to each other onto the rim. If not satisfactory repeat the initial procedure of making the base plate horizontal (see ch. [Installation](#) ¹⁰⁾).

5.7 Checking Accuracy of Measurement

To check the accuracy of measurement the SDI-12 verification command (`aV!`) is used. The accuracy check should be performed at dry weather and no or only light wind (wind speed less than 2 m/s, no gusts). To check accuracy, you need a precise reference weight (20, 25, 50, 100 or 200 gr) and a data logger which supports the SDI-12 transparent mode. Alternatively, you can use an accurate amount of water (doesn't apply to E-series precipitation gauges which can only be checked by a weight).

Procedure:

1. If connected to a running data logger, stop the measurement.
2. Empty the bucket.
3. Enter the SDI-12 transparent mode.
4. Enter the `aXclear!` command.
5. Wait for 2 minutes.

6. Put a reference weight on the bottom of the bucket. Try to place it precisely in the centre.
7. Wait for at least 3 minutes to be sure the internal calculation has finished.
8. Enter the `aV!` command. The response should be `a0001<CR><LF>`.
9. Enter the `aD0!` command. The test has passed if the returned value in millimetres lies within the interval Minimum..Maximum for given reference weight and orifice area (see table below).
10. Remove the reference weight.
11. Enter the `aXclear!` command once again so that the precipitation measured during the test won't be read by data logger.
12. Leave the SDI-12 transparent mode and resume the measurement.

PreciBalReference weight [g]	PreciBal 200			PreciBal 314		
	Minimum [mm]	Precise value [mm]	Maximum [mm]	Minimum [mm]	Precise value [mm]	Maximum [mm]
20	0.99	1	1.01	0,666	0,673	0,680
25	1.238	1.25	1.263	0,690	0,696	0,703
50	2.475	2.5	2.525	1,577	1,592	1,608
100	4.95	5	5.05	3,155	3,185	3,215
200	9.90	10	10,1	6,310	6,370	6,430

6 Repair

KISTERS precision instruments and data loggers are produced in quality-controlled processes. All KISTERS production and assembly sites in Australia, New Zealand and Europe are ISO 90001 certified. All equipment is factory tested and/or factory calibrated before it is shipped to the client. This ensures that KISTERS products perform to their fullest capacity when delivered.

Despite KISTERS most rigorous quality assurance (QA), malfunction may occur within or outside of the warranty period. In rare cases, a product may not be delivered in accordance with your order.

In such cases KISTERS' return and repair policy applies. For you as a customer, this means the following:

- Contact KISTERS using the Repair Request Form and the Declaration of Contamination made available online:

Region (Language)	Download Link
Asia-Pacific (English)	Repair Request Form (APAC) Declaration of Contamination (APAC)
Europe, the Middle East and Africa (English)	Repair Request Form (EMEA) Declaration of Contamination (EMEA)
Germany (German)	Repair Request Form (DE) Declaration of Contamination (DE)

In response you will receive a reference number that must be referenced on all further correspondence and on the freight documents accompanying your return shipment.

- Please provide as much information and/or clear instructions within the return paperwork. This will assist our test engineers with their diagnosis.
- Please do not ship the goods prior to obtaining the reference number. KISTERS will not reject any equipment that arrives without reference number; however, it may take us longer to process.

Custom requirements for items sent to KISTERS for warranty or non-warranty repairs: Check with your national customs/tax authorities for details, processes and paperwork regarding tax exempt return of products. Typically, special custom tariff codes are available (such as HS Code = 9802.00) that verify the item is being returned for repair and has no commercial value. Please note that the customs invoice / dispatch documents should also clearly state: "Goods being returned to manufacturer for repair - No Commercial value". It is mandatory to have any returned goods accompanied by a commercial invoice on headed paper. KISTERS reserves the right to charge the customer for time spent rectifying incorrect customs documents.

Note: Please ensure that your goods are packed carefully and securely. Damage that occurs during transit is not covered by our warranty and may be chargeable.

7 Technical Data

	Model	
	PreciBal 200	PreciBal 314
Orifice area	200 cm ²	314 cm ²
Precipitation range	Unlimited	
Accuracy of precipitation amount	± 0.025 or ± 1 %	0.016 mm or ± 1 %
Accuracy of precipitation intensity	± 1.5 mm/h or ± 1 %	
Threshold for precipitation amount	0.025 mm/40 min.	0.016 mm/40 min.
Threshold for precipitation intensity	0.025 mm/min.	0.016 mm/min.
Maximum precipitation intensity	2000 mm/h	
Resolution	0.001 mm	
Measuring element	Strain-gauge bridge	
Supply voltage	5 ... 30 VDC (reverse polarity protected)	
Power consumption	max 40 mW, typ 1.2 mA at 12 VDC	
Heating voltage (heating power)	10 ... 28 VDC / 0.8 .. 2.5 A (8 .. 75 W)	
Pulse output	relay contact; 2 Hz (250:250 ms); 1/0.1/0.01 mm/pulse 1 / 0.1 / 0.01 / 0.001 inch/pulse; 24V/0.5A max.	
Interfaces	SDI-12, RS-485 2Wire (300 ... 115200bps), Bluetooth LE, USB over Bluetooth	
Communication protocols	SDI-12 V1.4, MODBUS RTU, MODBUS ASCII, HS ASCII	
Connectors	M12 8-pin; M12 4-pin (for optional heater)	
Dimensions Instrument	Ø385 x 650 mm	Ø385 x 630 mm
Weight	9.5 kg	9.5 kg
Operation temperature	Unheated version: -40 ... +70 °C (with antifreeze below +4°C, no snow accumulation or ice accretion)	

	Model	
	PreciBal 200	PreciBal 314
	Heated version: -40 ... +70 °C (with heating at 24 VDC)	
Deployment temperature range	-40 ... +70 °C	
Operation humidity	0 ... 100 %	
Degree of protection	IP65	
Surge protection	all inputs/outputs	

8 Obligations of the Operator and Disposal

This chapter contains the following subsections:

- [Obligations of the Operator](#) ⁴⁶
- [Dismantling / Disposal](#) ⁴⁶

8.1 Obligations of the Operator

European Union

In the Single European Market it is the responsibility of the operator to ensure that the following legal regulations are observed and complied with: national implementation of the framework directive (89/391/EEC) and the associated individual directives, in particular 2009/104/EC, on minimum safety and health requirements for the use of work equipment by employees at work.

Worldwide

Regulations: If and where required, operating licences must be obtained by the operator. In addition, national or regional environmental protection requirements must be complied with, regardless of local legal provisions regarding the following topics:

- Occupational safety
- Product disposal

Connections: Local regulations for electrical installation and connections must be observed.

8.2 Dismantling / Disposal

When disposing of the units and their accessories, the applicable local regulations regarding environment, disposal and occupational safety must be observed.

Before dismantling

- Electrical Devices:
 - Switch off the units.
 - Disconnect electrical appliances from the power supply, regardless of whether the appliances are connected to the mains or to another power source.
- Mechanical devices:
 - Fix all loose components. Prevent the device from moving independently or unintentionally.
 - Loosen mechanical fastenings: Please note that appliances can be heavy and that loosening the fastenings may cause them to become mechanically unstable.

Disposal

Operators of old appliances must recycle them separately from unsorted municipal waste. This applies in particular to electrical waste and old electronic equipment.

Electrical waste and electronic equipment must not be disposed of as household waste!

Instead, these old appliances must be collected separately and disposed of via the local collection and return systems.

Integrated or provided batteries and accumulators must be separated from the appliances and disposed of at the designated

collection point. At the end of its service life, the lithium-ion battery must be disposed of according to legal provisions.

EU WEEE Directive

As players in the environmental market, KISTERS AG is committed to supporting efforts to avoid and recycle waste. Please consider:

- Avoidance before recycling!
- Recycling before disposal!



This symbol  indicates that the scrapping of the unit must be carried out in accordance with Directive 2012/19/EU. Please observe the local implementation of the directive and any accompanying or supplementary laws and regulations.

9 Appendices

This chapter contains the following subsections:

- [HS PreciBal \(RainBal\) App](#)

9.1 HS PreciBal (RainBal) App

The PreciBal (RainBal) App is changing the way you interact with the device. The PreciBal (RainBal) App provides a suite of innovative, easy to use features that put the power of the device right in the palm of your hand.

The PreciBal (RainBal) App connects to the device using Bluetooth®.

The App is available for free for Android and iOS.

9.1.1 PreciBal/RainBal App Functionality in a Nutshell

- Pair with and connect to your device(s).
- Access measurement data from various registers with numerical and graphical visualisation.
- Display and edit selected parameter settings.
- Display and forward log data by email (device status information).
- Update the Firmware.

9.1.2 Precibal/RainBal App – User Interface

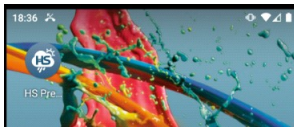

To start the PreciBal (RainBal) App: Click the PreciBal (RainBal) Icon on your smartphone and tablet.

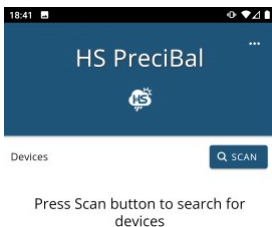

The App opens. Press the **[SCAN]** button to start scanning for nearby devices.

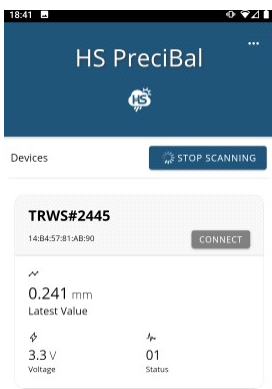

The App starts searching for devices. When a device is found it is inserted in a list. The **[CONNECT]** button enables you to connect to a specific device. Once the device you want to connect to is found, you may want to “STOP SCANNING”.

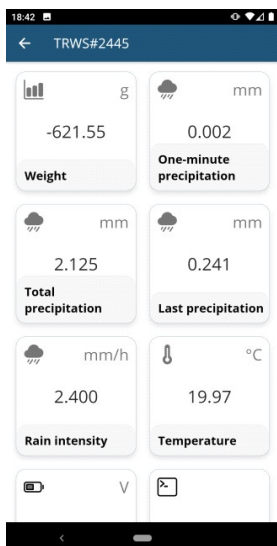

Once properly connected, the PreciBal (RainBal) App shows the latest readings from the device.

Each value is shown in a separate tile.

Depending on your device, the list of tiles may be too long to fit the screen. Use the usual touch display functions to scroll up and down to view all values or a desired specific data value.



Tiles are active elements, just like a button. Clicking a tile gives access to a detailed view on the data.

The screenshot on the left-hand side visualises “Total precipitation” data with a line graph showing on top and a numeric table of individual values at the bottom.

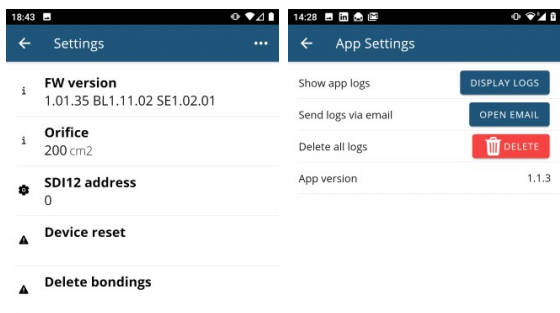

Other tiles provide access to device settings as illustrated in the screenshots.



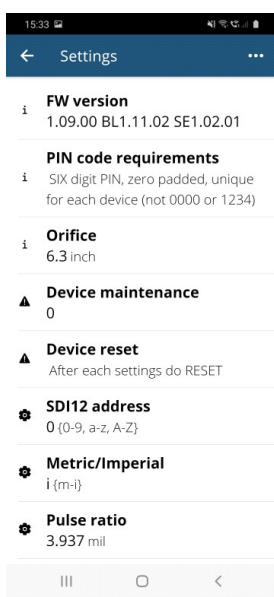
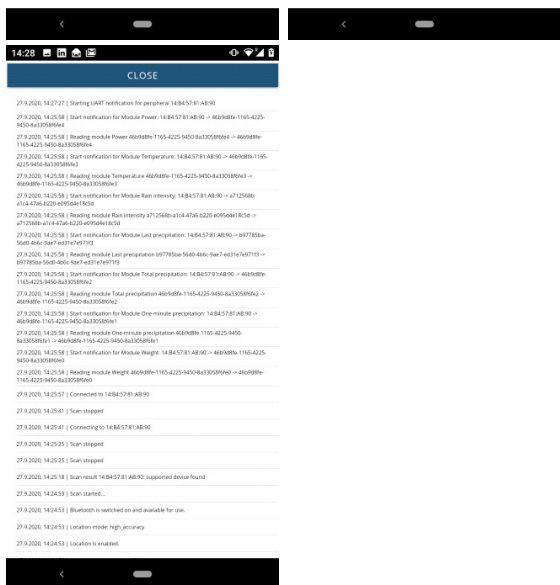

Device status log information can be viewed on the mobile device and/or forwarded by email.

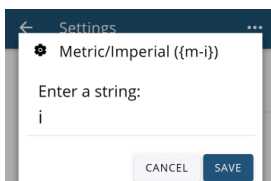

Changing physical units: The default setting is metric units. Use the **SETTINGS** menu of the App to switch to imperial units. The setting is performed manually: entering 'm' sets metric units, entering 'i' sets imperial units. To activate the settings, reset the device (also using the **SETTINGS** menu of the App).



Contact Data

Europe	KISTERS Europe	 +49 2408 9385 0
		 hydromet.sales@kisters.eu
		 www.kisters.eu
Australia	KISTERS Australia	 +612 9601 2022
		 sales@kisters.com.au
		 www.kisters.com.au
New Zealand	KISTERS New Zealand	 +64 7 857 0810
		 sales@kisters.co.nz
		 www.kisters.co.nz
Latin America	KISTERS Latin America	 +57 350 575 4079
		 sales@kisters-latam.com
		 www.kisters-latam.com
North America	KISTERS North America	 +1 561 459 4876
		 kna@kisters.net
		 www.kisters.net
Spain	KISTERS Ibérica	 info@kisters.es
		 www.kisters.es

