



/ HydroMet

User Manual

BLSH

 **KISTERS**
Empowering decisions of tomorrow

Table of Contents

I	Disclaimer	3
II	Scope of Delivery	4
III	Safety Instructions	5
Part I	Introduction	6
Part II	Assembly	7
Part III	Configuration	8
Part IV	Operation	9
Part V	Repair	10
Part VI	Technical Data	11
Part VII	Obligations of the Operator and Disposal	12
7.1	Obligations of the Operator	12
7.2	Dismantling / Disposal	12
Part VIII	Appendices	14

I Disclaimer

The information provided in this manual was deemed accurate as of the publication date. However, updates to this information may have occurred.

This manual does not include all of the details of design, production, or variation of the equipment nor does it cover every possible situation which may arise during installation, operation or maintenance. KISTERS shall not be liable for any incidental, indirect, special or consequential damages whatsoever arising out of or related to this documentation and the information contained in it, even if KISTERS has been advised of the possibility of such damages.

Any errors found in any KISTERS product should be reported to KISTERS where every effort will be made to quickly resolve the problem.

Copyright Notice: No parts of this work may be reproduced in any form or by any means without the written permission of the publisher. KISTERS waives copyright for users to print out parts of the documentation in hard copy for their own use only.

Trademark Notice: KISTERS products and services referred to in this document are trademarks or registered trademarks of KISTERS. Other product names used may or may not be the trademarks of their respective owners.

© 2025 | KISTERS. Any rights not expressly granted herein are reserved.

This document is public.

II Scope of Delivery

- Sampler
- 1 m wading rod (2 sections each 0.5 m), stainless steel (additional 0.5 m sections available on request)
- SB-01 sample bags (two supplied)
- Canvas carry bag for BLSH

III Safety Instructions

- Read the user manual including all operating instructions prior to installing, connecting and powering up the KISTERS BLSH. The manual provides information on how to operate the product. The manual is intended to be used by qualified personnel, i.e. personnel that have been adequately trained, are sufficiently familiar with installation, mounting, wiring, powering up and operation of the product.
- Keep the user manual on hand for later reference!
- If you encounter problems understanding the information in the manual (or part thereof), please consult the manufacturer or its appointed reseller for further support.
- KISTERS BLSH is intended to be used in hydrometeorological or environmental monitoring applications.
- Before starting to work, you have to check the functioning and integrity of the system.
 - Check for visible defects on the BLSH, this may or may not include any or all of the following mounting facilities, connectors and connections, mechanical parts, internal or external communication devices, power supplies or power supply lines, etc.
 - If defects are found that jeopardize the operational safety, work must be stopped. This is true for defects found before starting to work as well as for defects found while working.
- Do not use the KISTERS BLSH in areas where there is a danger of explosion.
- The present user manual specifies environmental/climatic operating conditions as well as mechanical and electrical conditions. Installation, wiring, powering up and operating the KISTERS BLSH must strictly comply with these specifications.
- Perform maintenance only when tools or machinery are not in operation.
- If guards are removed to perform maintenance, replace them immediately after servicing.
- Never make any electrical or mechanical diagnostics, inspections or repairs under any circumstances. Return the product to the manufacturer's named repair centre. You can find information on how to return items for repair in the relevant section of the KISTERS website.



Disposal instructions: After taking the KISTERS BLSH out of service, it must be disposed of in compliance with local waste and environmental regulations. The KISTERS BLSH is never to be disposed in household waste!



Inputs and outputs of the device are protected against electric discharges and surges (so-called ESD). Do not touch any part of the electronic components! If you need to touch any part, please discharge yourself, i.e. by touching grounded metal parts.

1 Introduction

Thank you for choosing our product. We hope you will enjoy using the device.

KISTERS manufactures, sells, installs and operates quality instrumentation, data loggers and communication technology. Products are designed with passion for environmental monitoring and with a deep understanding of the quality, accuracy and robustness needed to fulfil the requirements of measurement practitioners in the field.

The present User Manual will help you understand, install and deploy the device. If, however, you feel that a particular information is missing, incomplete or confusing, please do not hesitate to contact us for further support!

KISTERS' bed load sampler BLSH is an easy-to-use hand-held sampler for measuring and analysing coarse sand, silt, gravel, rock or other insoluble materials carried by a stream on or immediately above its bed.

2 Assembly

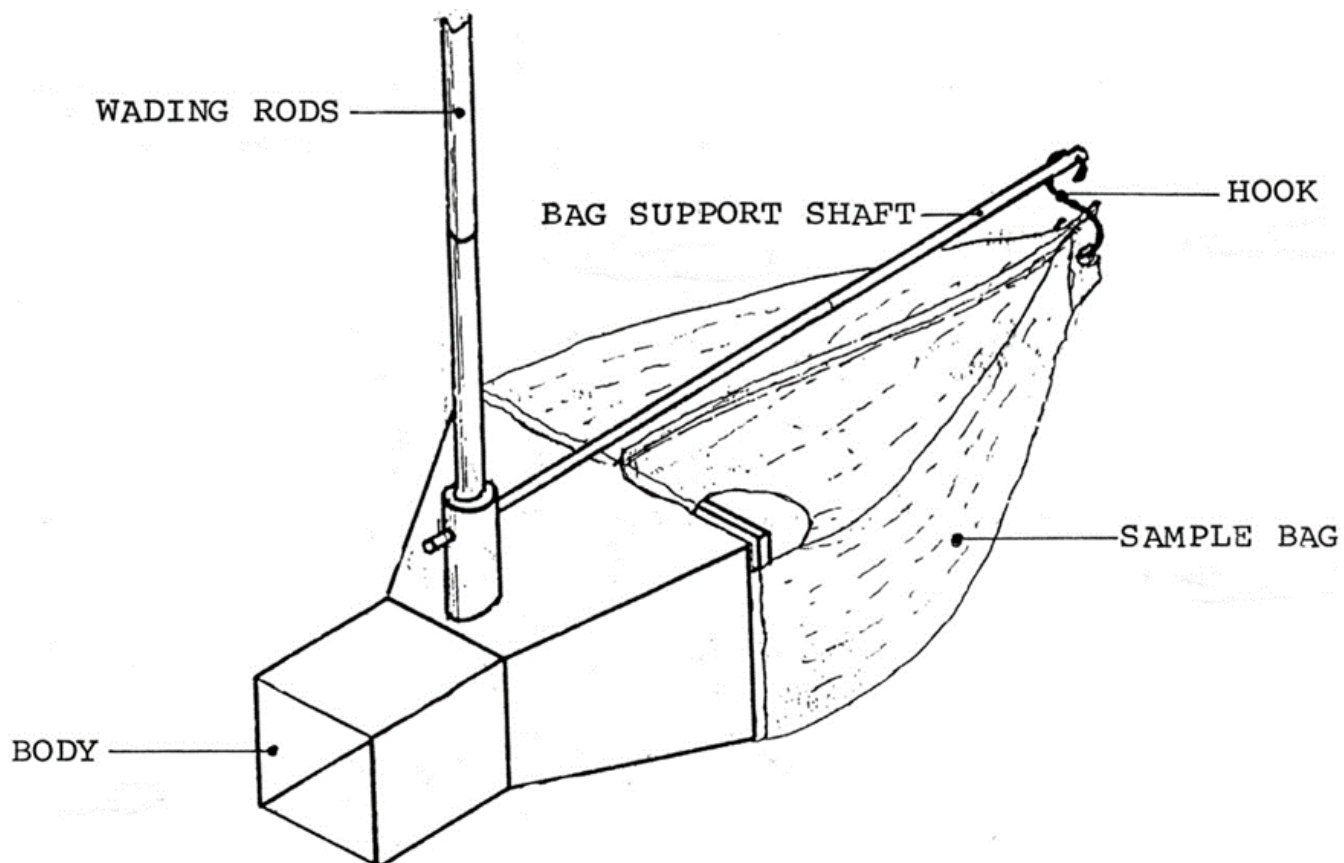

Insert dimple end of bag support shaft (BLSH02-01) into boss on body (BLSH01-01), screw in wading rod (DH48-04) to lock bag support shaft in position. Screw in 2nd wading rod.

Attach sample bag (SB-01) with seam uppermost, to rear of body, ensuring elastic band is located in body groove. Connect hook to eye in rear of sample bag.

3 Configuration

BLSH is a purely mechanical instrument. No specific configuration is required.

4 Operation

- Locate sampling points at the centroid of equal discharge panels in the stream (by current meter measurement).
- Place sampler on the stream bed (being careful not to dig in the nozzle) with nozzle pointing upstream at right angles to crossing.
- Collect a sample over a timed period, ensuring the sample bag is not filled more than 40 %.
- Record time and location.
- Remove sample bag and wet weigh sample.
- Empty and wash out sample bag.
- Continue sampling operation.

5 Repair

KISTERS precision instruments and data loggers are produced in quality-controlled processes. All KISTERS production and assembly sites in Australia, New Zealand and Europe are ISO 90001 certified. All equipment is factory tested and/or factory calibrated before it is shipped to the client. This ensures that KISTERS products perform to their fullest capacity when delivered.

Despite KISTERS most rigorous quality assurance (QA), malfunction may occur within or outside of the warranty period. In rare cases, a product may not be delivered in accordance with your order.

In such cases KISTERS' return and repair policy applies. For you as a customer, this means the following:

- Contact KISTERS using the Repair Request Form and the Declaration of Contamination made available online:

Region (Language)	Download Link
Asia-Pacific (English)	Repair Request Form (APAC) Declaration of Contamination (APAC)
Europe, the Middle East and Africa (English)	Repair Request Form (EMEA) Declaration of Contamination (EMEA)
Germany (German)	Repair Request Form (DE) Declaration of Contamination (DE)

In response you will receive a reference number that must be referenced on all further correspondence and on the freight documents accompanying your return shipment.

- Please provide as much information and/or clear instructions within the return paperwork. This will assist our test engineers with their diagnosis.
- Please do not ship the goods prior to obtaining the reference number. KISTERS will not reject any equipment that arrives without reference number; however, it may take us longer to process.

Custom requirements for items sent to KISTERS for warranty or non-warranty repairs: Check with your national customs/tax authorities for details, processes and paperwork regarding tax exempt return of products. Typically, special custom tariff codes are available (such as HS Code = 9802.00) that verify the item is being returned for repair and has no commercial value. Please note that the customs invoice / dispatch documents should also clearly state: "Goods being returned to manufacturer for repair - No Commercial value". It is mandatory to have any returned goods accompanied by a commercial invoice on headed paper. KISTERS reserves the right to charge the customer for time spent rectifying incorrect customs documents.

Note: Please ensure that your goods are packed carefully and securely. Damage that occurs during transit is not covered by our warranty and may be chargeable.

6 Technical Data

Type	Handheld bed load sampler
Orifice	76 × 76 mm
Expansion Ratio	3.22 (exit area to entrance area)
Body	Epoxy coated cast aluminium
Packed Dimensions	<ul style="list-style-type: none">▪ Size: 60 × 30 × 30 cm▪ Volume: 0.03 m³▪ Weight: 3 kg

7 Obligations of the Operator and Disposal

This chapter contains the following subsections:

- [Obligations of the Operator](#) ¹²
- [Dismantling / Disposal](#) ¹²

7.1 Obligations of the Operator

European Union

In the Single European Market it is the responsibility of the operator to ensure that the following legal regulations are observed and complied with: national implementation of the framework directive (89/391/EEC) and the associated individual directives, in particular 2009/104/EC, on minimum safety and health requirements for the use of work equipment by employees at work.

Worldwide

Regulations: If and where required, operating licences must be obtained by the operator. In addition, national or regional environmental protection requirements must be complied with, regardless of local legal provisions regarding the following topics:

- Occupational safety
- Product disposal

Connections: Local regulations for electrical installation and connections must be observed.

7.2 Dismantling / Disposal

When disposing of the units and their accessories, the applicable local regulations regarding environment, disposal and occupational safety must be observed.

Before dismantling

- Electrical Devices:
 - Switch off the units.
 - Disconnect electrical appliances from the power supply, regardless of whether the appliances are connected to the mains or to another power source.
- Mechanical devices:
 - Fix all loose components. Prevent the device from moving independently or unintentionally.
 - Loosen mechanical fastenings: Please note that appliances can be heavy and that loosening the fastenings may cause them to become mechanically unstable.

Disposal

Operators of old appliances must recycle them separately from unsorted municipal waste. This applies in particular to electrical waste and old electronic equipment.

Electrical waste and electronic equipment must not be disposed of as household waste!

Instead, these old appliances must be collected separately and disposed of via the local collection and return systems.

Integrated or provided batteries and accumulators must be separated from the appliances and disposed of at the designated

collection point. At the end of its service life, the lithium-ion battery must be disposed of according to legal provisions.

EU WEEE Directive

As players in the environmental market, KISTERS AG is committed to supporting efforts to avoid and recycle waste. Please consider:

- Avoidance before recycling!
- Recycling before disposal!



This symbol  indicates that the scrapping of the unit must be carried out in accordance with Directive 2012/19/EU. Please observe the local implementation of the directive and any accompanying or supplementary laws and regulations.

8 Appendices

WATER RESOURCES BULLETIN

VOL. 20, NO. 2

AMERICAN WATER RESOURCES ASSOCIATION

APRIL 1984

A FIELD TECHNIQUE FOR WEIGHING BEDLOAD SAMPLES¹William P. Carey²

ABSTRACT: A technique for weighing bedload samples that was developed for laboratory use has been modified for field application. The technique involves determining the submerged weight of bedload samples as they are collected. The submerged weights are converted to dry weights from a knowledge of the specific gravity of the bedload material. The technique makes bedload transport data available immediately and eliminates costly and time-consuming steps involved with saving samples for laboratory analysis. Only samples designated for particle-size or other lab analyses need to be saved.
(KEY TERMS: bedload; sampling; field techniques.)

INTRODUCTION

Current bedload sampling procedures usually require that each sample be individually bagged and labeled as it is collected in the field. Then, depending upon the objective of the sampling program, the individual samples can be composited or analyzed separately in the laboratory. The entire sample handling process involves numerous steps (bagging, labeling, logging-in, drying, weighing), resulting in considerable expenditure of time. Bedload data are not likely to be available for days or even weeks following a sampling effort, particularly if all the samples have to be shipped to a laboratory facility.

For most bedload samples only the dry weight of material is required. Thus, in order to decrease the time and manpower needed to analyze bedload samples, a weighing technique developed for bedload sampler calibration (Hubbell, *et al.*, 1981) has been modified for use in the field. This technique eliminates the need for saving samples in the field and, subsequently, drying and weighing them in the lab. Only those samples designated for particle-size or other lab analyses need to be saved for the lab.

THEORY OF OPERATION

The proposed field method measures the submerged weight of each sample in the field. The conversion of submerged weights to dry weights is based on the following derivation. The derivation is presented in detail in order to clarify the terms being used.

The specific weight of a sediment sample (γ_s) is defined as the dry weight (W_{ds}) of the sampled material per unit volume (V_s).

$$\gamma_s = \frac{W_{ds}}{V_s} \quad (1)$$

The specific gravity of the material (SG_s) is defined as the ratio of its specific weight to the specific weight of water (γ_w) at 4°C.

$$SG_s = \frac{\gamma_s}{\gamma_w} \quad (2)$$

The specific weight of the material is then:

$$\gamma_s = SG_s \gamma_w \quad (3)$$

From Equations (1) and (3) the dry weight of a volume of material is given by:

$$W_{ds} = V_s \gamma_s = V_s \gamma_w SG_s \quad (4)$$

The submerged weight (W_{ss}) of a volume of material is the dry weight of the volume of material minus the weight of an equal volume of water.

$$W_{ss} = V_s \gamma_s - V_s \gamma_w = V_s \gamma_w SG_s - V_s \gamma_w = V_s \gamma_w (SG_s - 1) \quad (5)$$

If the specific gravity of any amount of material taken from a sampling site is constant, then the ratio of dry weight to submerged weight for any sample should also be constant. This ratio is given by:

$$\frac{W_{ds}}{W_{ss}} = \frac{V_s \gamma_w SG_s}{V_s \gamma_w (SG_s - 1)} = \frac{SG_s}{SG_s - 1} \quad (6)$$

¹Paper No. 83144 of the *Water Resources Bulletin*.

²Hydrologist, U.S. Geological Survey, Water Resources Division, A-413 Federal Bldg., Nashville, Tennessee 37203.

Carey

being used. Some minor delays were encountered when two samplers were being operated simultaneously.

RESULTS

During field tests in a sand-bed channel of west Tennessee, six samples representing the range of sample weights encountered were saved for laboratory analysis. Table 1 shows the laboratory dry weight, the field dry weight computed from Equation (7) using $SG_s = 2.65$, and the percentage difference. No correlation seems to exist between sample weight and percentage difference; however, the field values are consistently lower than the laboratory values. The average of the six difference terms is -1.5 percent.

TABLE 1. Measured Dry Weight, Computed Dry Weight, and Difference in Percentage for Six Bedload Samples.

Laboratory Dry Weight, in Pounds	Field Dry Weight, in Pounds	Difference, in Percentage
0.162	0.159	-1.85
0.862	0.850	-1.39
1.103	1.094	-0.82
1.717	1.704	-0.76
3.380	3.347	-0.98
11.280	10.897	-3.40

The percentage difference term shown in Table 1 is defined as:

$$\begin{aligned} \text{difference in percentage} &= \left(\frac{\text{Field dry wt} - \text{Lab dry wt}}{\text{Lab dry wt}} \right) (100) \\ &= \left(\frac{\text{Field dry wt}}{\text{Lab dry wt}} - 1 \right) (100) \quad (8) \end{aligned}$$

Using the average difference of -1.5 percent from Table 2, Equation (8) can be expressed as follows:

$$-0.015 = \frac{\text{Field dry wt}}{\text{Lab dry wt}} - 1$$

$$\text{Lab dry wt} = \frac{\text{Field dry wt}}{0.985}$$

Substituting Equation (7) yields:

$$(W_{ss}) \frac{SG_s}{SG_s - 1} = \frac{1}{0.985} (W_{ss}) \left(\frac{SG_A}{SG_A - 1} \right)$$

where

$$SG_A = \text{assumed specific gravity} = 2.65$$

or

$$\frac{SG_s}{SG_s - 1} = \left(\frac{1}{0.985} \right) \left(\frac{2.65}{2.65 - 1} \right)$$

from which

$$SG_s = 2.59$$

Hence the average SG_s for the six samples is less than the assumed SG_s for a predominantly quartz sand.

The consistent underestimations of actual dry weight could be the result of real specific gravity departures from 2.65 due to mineral composition, air being trapped in the sample during transfer and submergence, and the presence of organic matter in the samples. While all of these factors probably contribute to the reduction in SG_s , field experience indicates that organic material most likely accounts for most of the reduction.

Obviously, using a sample size of six does not permit a rigorous error analysis. The six samples were saved primarily for particle-size analysis and secondarily to confirm reconnaissance data that showed the bedload was predominantly quartz sand. In areas where significant departures from $SG_s = 2.65$ are suspected, many more samples should be saved, and an in-depth error analysis should be conducted.

SUMMARY

Current bedload sampling procedures usually require that each sample be individually bagged and labeled as it is collected. These individual samples can then be composited or analyzed separately in the laboratory. The number of samples that have to be transported can be quite large when doing intensive sampling. Also, the manual laboratory analysis of these samples can be time-consuming and very costly, even if only the dry weight of the samples is determined.

The relatively inexpensive weighing system and technique described in this article provides an efficient means of obtaining timely bedload data in the field and eliminates the need for preserving numerous samples for laboratory analysis. The technique is based on the assumption that the specific gravity of the bedload is known and is essentially constant. Because natural erosion processes usually result in a quartz dominated sediment, the technique should be widely applicable.

LITERATURE CITED

- American Society of Civil Engineers, 1975. Sedimentation Engineering. Manual on Engineering Practice 54, New York, New York.
Carey, W. P., 1979. Sediment Characteristics of the New River Basin,

Carey

being used. Some minor delays were encountered when two samplers were being operated simultaneously.

RESULTS

During field tests in a sand-bed channel of west Tennessee, six samples representing the range of sample weights encountered were saved for laboratory analysis. Table 1 shows the laboratory dry weight, the field dry weight computed from Equation (7) using $SG_s = 2.65$, and the percentage difference. No correlation seems to exist between sample weight and percentage difference; however, the field values are consistently lower than the laboratory values. The average of the six difference terms is -1.5 percent.

TABLE 1. Measured Dry Weight, Computed Dry Weight, and Difference in Percentage for Six Bedload Samples.

Laboratory Dry Weight, in Pounds	Field Dry Weight, in Pounds	Difference, in Percentage
0.162	0.159	-1.85
0.862	0.850	-1.39
1.103	1.094	-0.82
1.717	1.704	-0.76
3.380	3.347	-0.98
11.280	10.897	-3.40

The percentage difference term shown in Table 1 is defined as:

$$\begin{aligned} \text{difference in percentage} &= \left(\frac{\text{Field dry wt} - \text{Lab dry wt}}{\text{Lab dry wt}} \right) (100) \\ &= \left(\frac{\text{Field dry wt}}{\text{Lab dry wt}} - 1 \right) (100) \quad (8) \end{aligned}$$

Using the average difference of -1.5 percent from Table 2, Equation (8) can be expressed as follows:

$$-0.015 = \frac{\text{Field dry wt}}{\text{Lab dry wt}} - 1$$

$$\text{Lab dry wt} = \frac{\text{Field dry wt}}{0.985}$$

Substituting Equation (7) yields:

$$(W_{ss}) \frac{SG_s}{SG_s - 1} = \frac{1}{0.985} (W_{ss}) \left(\frac{SG_A}{SG_A - 1} \right)$$

where

$$SG_A = \text{assumed specific gravity} = 2.65$$

or

$$\frac{SG_s}{SG_s - 1} = \left(\frac{1}{0.985} \right) \left(\frac{2.65}{2.65 - 1} \right)$$

from which

$$SG_s = 2.59$$

Hence the average SG_s for the six samples is less than the assumed SG_s for a predominantly quartz sand.

The consistent underestimations of actual dry weight could be the result of real specific gravity departures from 2.65 due to mineral composition, air being trapped in the sample during transfer and submergence, and the presence of organic matter in the samples. While all of these factors probably contribute to the reduction in SG_s , field experience indicates that organic material most likely accounts for most of the reduction.

Obviously, using a sample size of six does not permit a rigorous error analysis. The six samples were saved primarily for particle-size analysis and secondarily to confirm reconnaissance data that showed the bedload was predominantly quartz sand. In areas where significant departures from $SG_s = 2.65$ are suspected, many more samples should be saved, and an in-depth error analysis should be conducted.

SUMMARY

Current bedload sampling procedures usually require that each sample be individually bagged and labeled as it is collected. These individual samples can then be composited or analyzed separately in the laboratory. The number of samples that have to be transported can be quite large when doing intensive sampling. Also, the manual laboratory analysis of these samples can be time-consuming and very costly, even if only the dry weight of the samples is determined.

The relatively inexpensive weighing system and technique described in this article provides an efficient means of obtaining timely bedload data in the field and eliminates the need for preserving numerous samples for laboratory analysis. The technique is based on the assumption that the specific gravity of the bedload is known and is essentially constant. Because natural erosion processes usually result in a quartz dominated sediment, the technique should be widely applicable.

LITERATURE CITED

- American Society of Civil Engineers, 1975. Sedimentation Engineering. Manual on Engineering Practice 54, New York, New York.
Carey, W. P., 1979. Sediment Characteristics of the New River Basin,

Carey

Solving for dry weight yields:

$$W_{ds} = \frac{SG_s}{SG_s - 1} W_{ss} \quad (7)$$

If it can be shown that SG_s is essentially constant at a sampling site then Equation (7) can be used to find W_{ds} and the need to save every sample will be eliminated.

SPECIFIC GRAVITY OF SEDIMENT

Most sediment transport studies, and particularly those involving sand, assume that the specific gravity of the sediment is equal to that of quartz (2.65). Because of its great stability, quartz is by far the most common mineral found in fluvial sediment, particularly sand. Even when appreciable quantities of other minerals are present, analyses have shown that the specific gravity of sand is often very close to 2.65 (American Society of Civil Engineers, 1975). Therefore, in channels where the bed material is predominantly a quartz-dominated sand or gravel, the assumption of a constant specific gravity of approximately 2.65 is probably valid but should be verified by field data.

In those areas where quartz does not dominate the mineralogy, a considerable amount of field data may be required to establish a numerical value for the specific gravity. Other factors that may influence the specific gravity include organic material moving along the bed and accelerated erosion that produces a disproportionate supply of low or high specific gravity material. Accelerated erosion in coal mining areas, for instance, can supply a large amount of coal to the bedload (Carey, 1979). The specific gravity of coal usually ranges from about 1.0 to 1.8.

An acceptable level of variability for specific gravity cannot be defined because the accuracy of bedload samplers is difficult to define (Hubbell, *et al.*, 1981), and the accuracy of measurement techniques may vary depending on field conditions (de Vries, 1973). However, because natural erosion processes tend to produce a quartz-dominated sediment, significant variability in specific gravity should not be encountered frequently and the assumption of essentially constant specific gravity should be widely applicable.

FIELD WEIGHING SYSTEM

The most important component of the field weighing system is a battery operated electronic balance. The balance used in this study (Figure 1) is a K-tron top-loading balance that has been modified to allow weighing from below the unit. (Use of the brand or firm name in this paper is for identification purposes only and does not constitute endorsement by the U.S. Geological Survey.) The balance is rugged, needs only "eye-ball" leveling, automatically zeros when turned on, and runs for about 10 hours on an internal rechargeable battery. It has a liquid crystal display (LCD) and is designed to operate

accurately at temperatures ranging from 0°C (32°F) to 40°C (104°F).

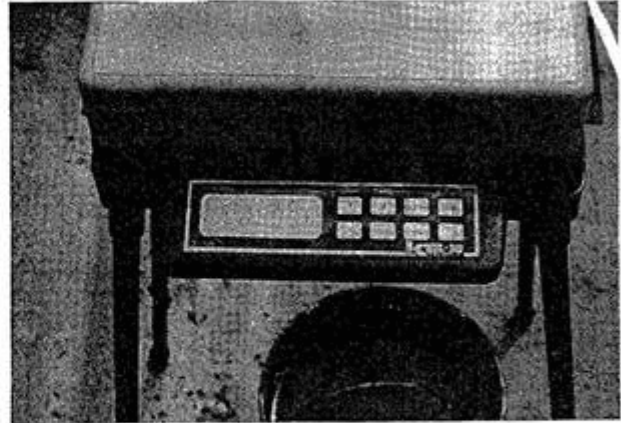

Figure 1. K-tron Top-Loading Balance.

A four-legged metal stand (Figure 2) was built to support the balance and a plexiglass wind cover has been designed for the top of the balance (Figure 3). The dimensions of the stand are not important as long as the balance is held securely and there is ample room to work below the balance. Initial field tests showed that low-speed air currents induced sufficient pressure differentials on the top of the balance to cause highly variable readings. Therefore, some sort of wind protection is necessary. The wind cover shown in Figure 3 also provides limited rain protection and a convenient place for writing field notes. When significant rainfall is expected during field operations, the balance can be set up in the back of a van. Field tests also showed that the LCD will blackout in direct sunlight; therefore, the wind cover should include some sort of shade for the LCD. This shade modification is not shown in Figures 2 and 3.



Figure 2. Field Weighing System.

A Field Technique for Weighing Bedload Samples

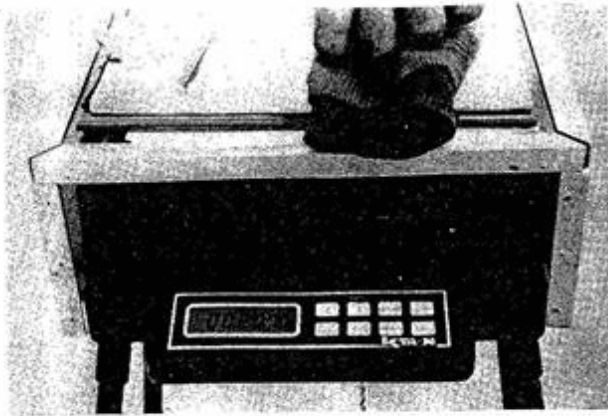

Figure 3. Balance With Wind Cover.

Small five-quart plastic buckets (Figure 4) are used to hold the bedload samples. A brass weight has been added to the bottom of each sample bucket (Figure 4) to facilitate obtaining a submerged tare weight when the bucket is empty. The diameter of the sample buckets should not exceed nine inches so they can be easily submerged in the larger water containers. If only one sampler is being used during field operations, then only one sample bucket is needed; however, three or four spare sample buckets should be available. Tare weights will vary among buckets, therefore all sample buckets should be numbered. The sample buckets are suspended from beneath the balance using a lightweight chain (Figure 2) and two S-hooks.

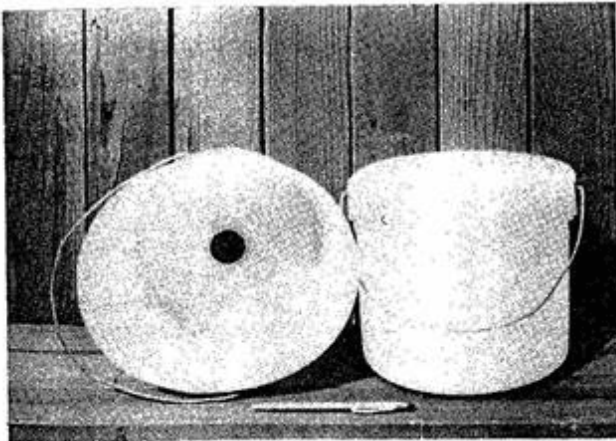

Figure 4. Five-Quart Plastic Buckets.

A five-gallon bucket is used to hold water for submerged weighing. An additional five-gallon bucket is used for rinsing (Figure 2). Although metal buckets are shown in Figure 2,

plastic buckets are recommended because they are more durable.

FIELD PROCEDURE

After setting up the balance as shown in Figure 2 and filling the five-gallon buckets with water, attach the chain and five-quart sample bucket to the bottom of the balance. Adjust the position of the chain on the top S-hook until the five-quart sample bucket is completely submerged. It is not necessary to completely submerge the handle of the sample bucket (Figure 1). Adjust the position of the five-gallon bucket so that the submerged sample bucket is freely suspended in the water. When these adjustments are finished, remove the sample bucket and turn on the balance. The balance will automatically zero, ignoring the weight of the chain and hooks. Select the desired units (kilograms or pounds) on the balance, obtain a submerged tare weight for each sample bucket and record it with the bucket number.

It is not necessary to turn the balance on and off each time a weight is obtained. If the battery in the balance was charged the night before, it should last about 10 hours. The balance is not designed to accept large instantaneous loads, so the operator must avoid snagging the chain or hook when submerging a bucket. Hold the chain with one hand and slowly submerge the bucket with the other hand. Sample buckets should always be submerged slowly to dampen oscillations in the five-gallon bucket and to prevent material from being washed out of the sample bucket. If the displayed readings vary due to water oscillations, the balance can be set to display a five-second average weight.

Bedload samples are emptied directly from the bedload sampler into the five-quart sample buckets. For each sample, the submerged weight of the bucket plus sample is carefully obtained using the described method. After the submerged weight and bucket number have been recorded, the sample bucket is carefully removed and as much water as possible is decanted back into the five-gallon weighing bucket. The sample is then discarded and the sample bucket is thoroughly rinsed. Using a separate five-gallon bucket for rinsing prevents the build-up of material in the weighing bucket, and it also eliminates the need for any vigorous activity in the vicinity of the balance.





For single sampler operations, the same sample bucket can be used to weigh each sample. If this bucket is rinsed thoroughly after each sample is weighed, then its submerged tare weight will remain constant. This constant weight can be accounted for by the balance, and the displayed weights will be the actual submerged weights of the samples.

Field tests with collection rates of approximately one sample every three minutes show that the entire process of obtaining the submerged weight, discarding the sample, and rinsing the sample bucket can be completed easily by one person while a second person is collecting the next bedload sample. The field weighing process does not add any time to, nor in any way encumber, the sampling process when a single sampler is

A Field Technique for Weighing Bedload Samples

- Carey, W. P., 1979. Sediment Characteristics of the New River Basin, Tennessee. *In: Proceedings Symposium on Surface Mining Hydrology, Sedimentology and Reclamation*. University of Kentucky, Bulletin 119, pp. 197-202.
- de Vries, M., 1973. On Measuring Discharge and Sediment Transport in Rivers. *International Seminar on Hydraulics of Alluvial Streams*, New Delhi, India, January 15-19, 1973. Delft Hydraulics Laboratory Publication 106, 15 pp.
- Hubbell, D. W., H. H. Stevens, Jr., J. V. Skinner, and J. P. Beverage, 1981. Recent Refinements in Calibrating Bedload Samplers. *In: Proceedings of the Specialty Conference, Water Forum '81*. American Society of Civil Engineers, San Francisco, California, Vol. 1: 1-13.

Contact Data

Europe	KISTERS Europe	 +49 2408 9385 0
		 hydromet.sales@kisters.eu
		 www.kisters.eu
Australia	KISTERS Australia	 +612 9601 2022
		 sales@kisters.com.au
		 www.kisters.com.au
New Zealand	KISTERS New Zealand	 +64 7 857 0810
		 sales@kisters.co.nz
		 www.kisters.co.nz
Latin America	KISTERS Latin America	 +57 350 575 4079
		 sales@kisters-latam.com
		 www.kisters-latam.com
North America	KISTERS North America	 +1 561 459 4876
		 kna@kisters.net
		 www.kisters.net
Spain	KISTERS Ibérica	 info@kisters.es
		 www.kisters.es

